

Precisely manufactured from cellular PVC, Entrance Trim from INTEX will not rot, shrink, expand or cup like wood. It is primed and ready to paint.

Table of Contents	
Component Pricing with Descriptions.....	E-2
How to Select and Order Trim.....	E-3
B-4 3-1/2" Fluted Trim Kits.....	E-4
B-5 4-1/2" Reeded Trim Kits.....	E-5
B-6 5-1/2" Fluted Trim Kits.....	E-6
B-9 8-1/2" Fluted Trim Kits.....	E-7
Trim Details and Dimensions.....	E-8
Adjustability Features.....	E-9

Single Door:		List
B-4	3'-0" Basic Trim Kit	\$174.53
B-5	3'-0" Basic Trim Kit w/Plinths	271.63
B-6	3'-0" Basic Trim Kit w/Plinths	291.29
B-9	3'-0" Basic Trim Kit	444.78
B-3D	3'-0" Dentil Head	282.78
B-3F	3'-0" Frieze Board Head	155.54
B-3P	3'-0" Pediment Head	234.30

Double Door and Door with Sidelights:		List
B-4	6'-4" Basic Trim Kit w/mull casing	\$276.50
B-5	6'-4" Basic Trim Kit w/plinths & mull casing	363.63
B-6	6'-4" Basic Trim Kit w/plinths & mull casing	397.32
B-9	6'-4" Basic Trim Kit w/mull casing	528.51
B-6D	6'-4" Dentil Head	559.90
B-6F	6'-4" Frieze Board Head	235.22
B-6P	6'-4" Pediment Head	321.44
B-6R	Ram's Head	<i>974.90</i>
B-6S	Sunburst Head	470.65

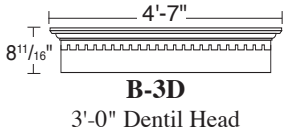

B-3D

3'-0" Dentil Head

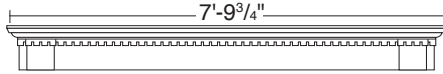

B-6D

6'-4" Dentil Head

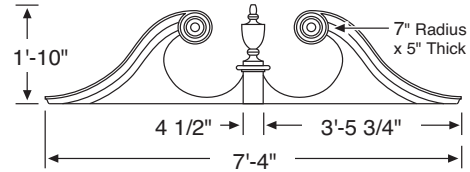

B-6R

Adjustable Ram's Head

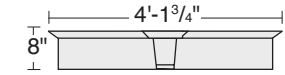

B-3F

3'-0" Frieze Board Head

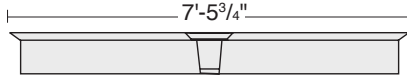

B-6F

6'-4" Frieze Board Head

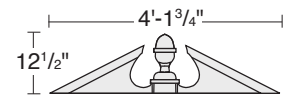

B-3P

3'-0" Pediment Head

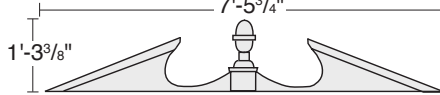

B-6P

6'-4" Pediment Head

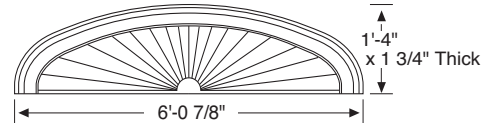

B-6S

Sunburst

3'-0" Shelf
(included in basic trim kit)

7'-2 1/2" Shelf
(included in basic trim kit)

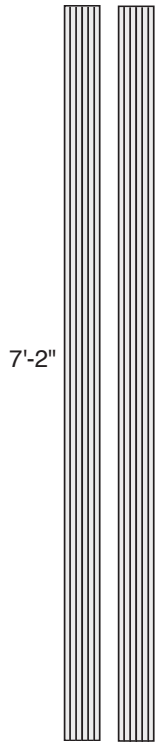

B-4 Pilaster
3 1/2" (Fluted)

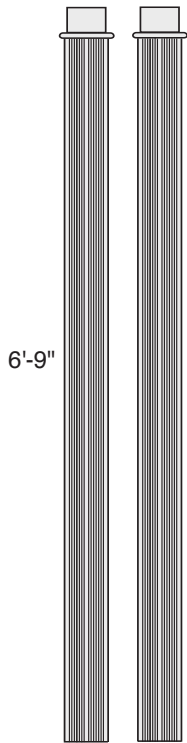

B-5 Pilaster
4 1/2" (Reeded)

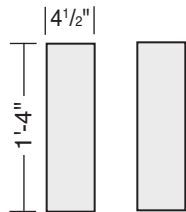

B-5
Plinth Blocks
(included w/trim)

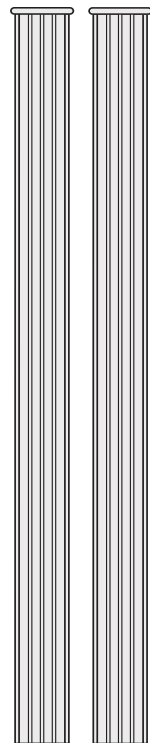

B-6 Pilaster
5 1/2" (Fluted)

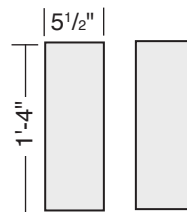

B-6
Plinth Blocks
(included w/trim)

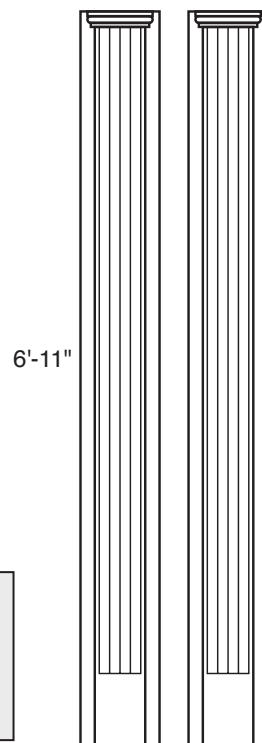

B-9 Pilaster
8 1/2" (Fluted)



Mullion Casing

NOTE: Items priced in *italics* are Factory Order - Please allow additional lead time.

How to select Entrance Trim

1. Determine which application configuration you have.



2. Then determine which pilaster design you prefer.

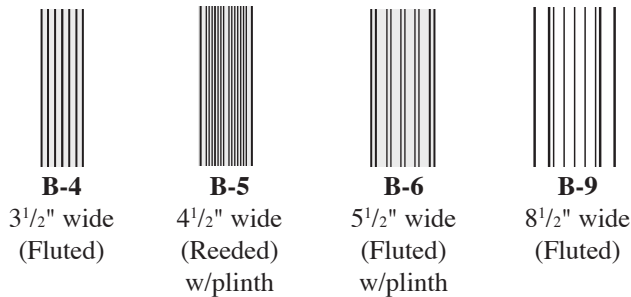

• Any of the designs can be used for "A", "B" or "C" applications.

3. For configuration "A" select basic trim (B-4, B-5, B-6 or B-9 **3'-0"**).

For configuration "B" and "C" select basic trim (B-4, B-5, B-6 or B-9 **6'-4"**).

4. Select the head(s) that best suit the architectural style of your home.



B-3D
Dentil Head
(for use w/B-9 Trim only)
"A" ONLY

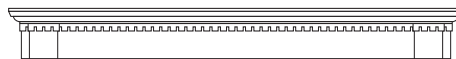

B-6D
Dentil Head
"B" & "C"

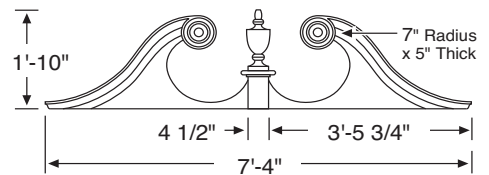

B-6R
Ram's Head (Adjustable)
"B" & "C"



B-3F
Frieze Board
(Adjustable)
"A"

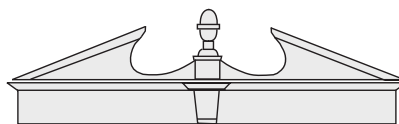

B-6P
B-6F
Pediment Head with Frieze Board
(Adjustable)
"B" & "C"

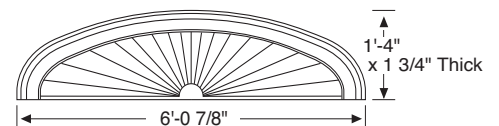

B-6S
(3'-0" Door w/1'-0" Sidelights only)
"B"



B-3P
Pediment Head
(Adjustable)
"A"

How to measure:

1. **Measurement "A" = width of opening.**

Measure width of opening from jamb to jamb plus 1" (1/2" each side).

2. **Measurement "B" = width of pilaster desired.**

Measure from desired reveal on jamb (usually 1/2") out 3 1/2", 4 1/2", 5 1/2" or 9 1/2" depending on which pilaster design you select.

3. **Measurement "C" = height of head(s).**

Measure up from desired reveal at top jamb (usually 1/2").

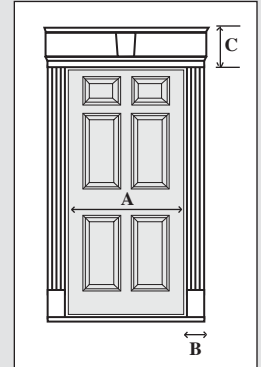

• For shelf only, allow 2³/₄".

• For shelf and frieze board allow 10³/₄".

• For shelf and pediment head allow 1'-3¹/₄" when using 3'-0" widths, 1'-6¹/₈" when using 6'-4" widths.

• For shelf, frieze board and pediment head allow 1'-11¹/₄" when using 3'-0" widths, 2'-2¹/₈" when using 6'-4" widths.

B-4 Entrance Trim

- For Door Units up to 7'-0" in Height
- 2-1/4" Mullion Casing
- 3-1/2" Fluted Pilasters

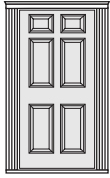

Basic Trim
B-4
\$174.53



Basic Trim &
Pediment Head
\$408.83



Basic Trim &
Frieze Board Head
\$330.07



Basic Trim, Frieze Board &
Pediment Head
\$564.37

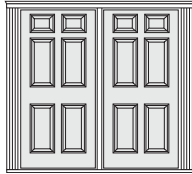

Basic Trim
B-4
\$276.50

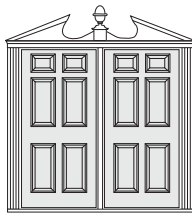

Basic Trim &
Pediment Head
\$597.94

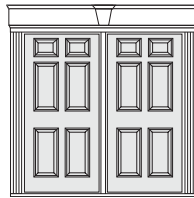

Basic Trim &
Frieze Board Head
\$511.72

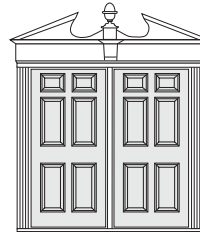

Basic Trim, Frieze Board &
Pediment Head
\$833.16



Basic Trim &
Ram's Head
\$1251.40

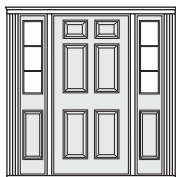

Basic Trim
B-4
\$276.50

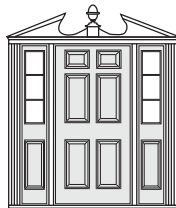

Basic Trim &
Pediment Head
\$597.94

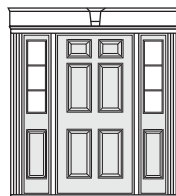

Basic Trim &
Frieze Board Head
\$511.72

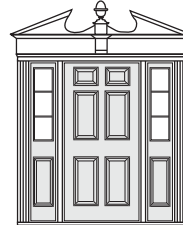

Basic Trim, Frieze Board &
Pediment Head
\$833.16



Basic Trim &
Ram's Head
\$1251.40

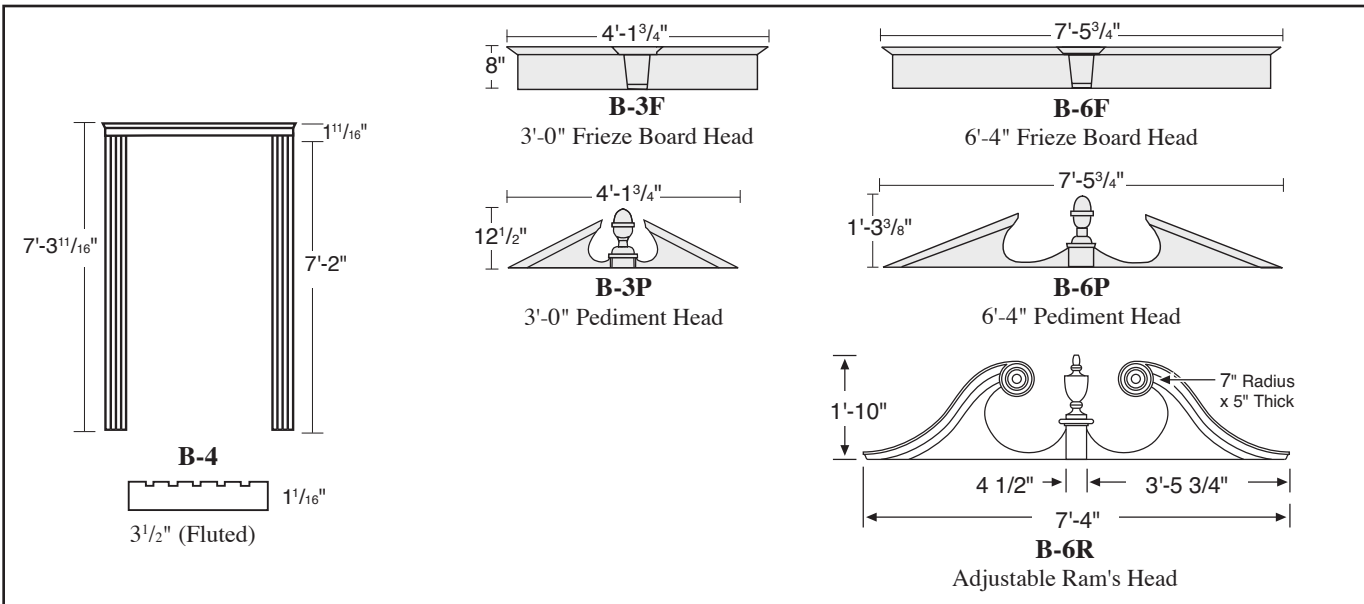

Plinth Blocks not available.

For Individual Component Pricing - See Page E-2

NOTE: Items priced in *italics* are Factory Order - Please allow additional lead time.

B-5 Entrance Trim

- For Door Units up to 7'-0" in Height
- 2-1/4" Mullion Casing
- 4-1/2" Reeded Pilasters w/Plinth Blocks

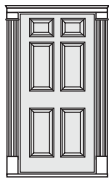

Basic Trim
B-5
\$271.63



Basic Trim &
Pediment Head
\$505.93



Basic Trim &
Frieze Board Head
\$427.17



Basic Trim, Frieze Board &
Pediment Head
\$661.47

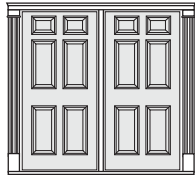

Basic Trim
B-5
\$363.63

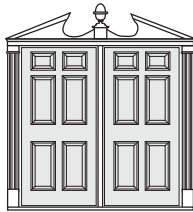

Basic Trim &
Pediment Head
\$685.07

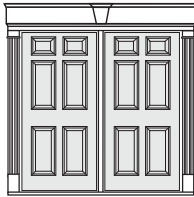

Basic Trim &
Frieze Board Head
\$598.85

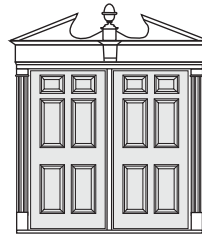

Basic Trim, Frieze Board &
Pediment Head
\$920.29

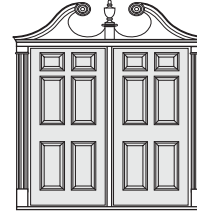

Basic Trim &
Ram's Head
\$1338.53

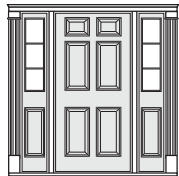

Basic Trim
B-5
\$363.63



Basic Trim &
Pediment Head
\$685.07

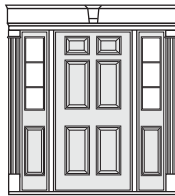

Basic Trim &
Frieze Board Head
\$598.85

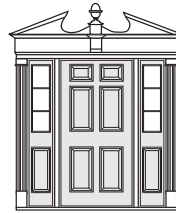

Basic Trim, Frieze &
Pediment Head
\$920.29



Basic Trim &
Ram's Head
\$1338.53

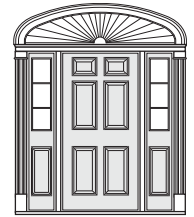

Basic Trim &
Sunburst Head*
\$834.28

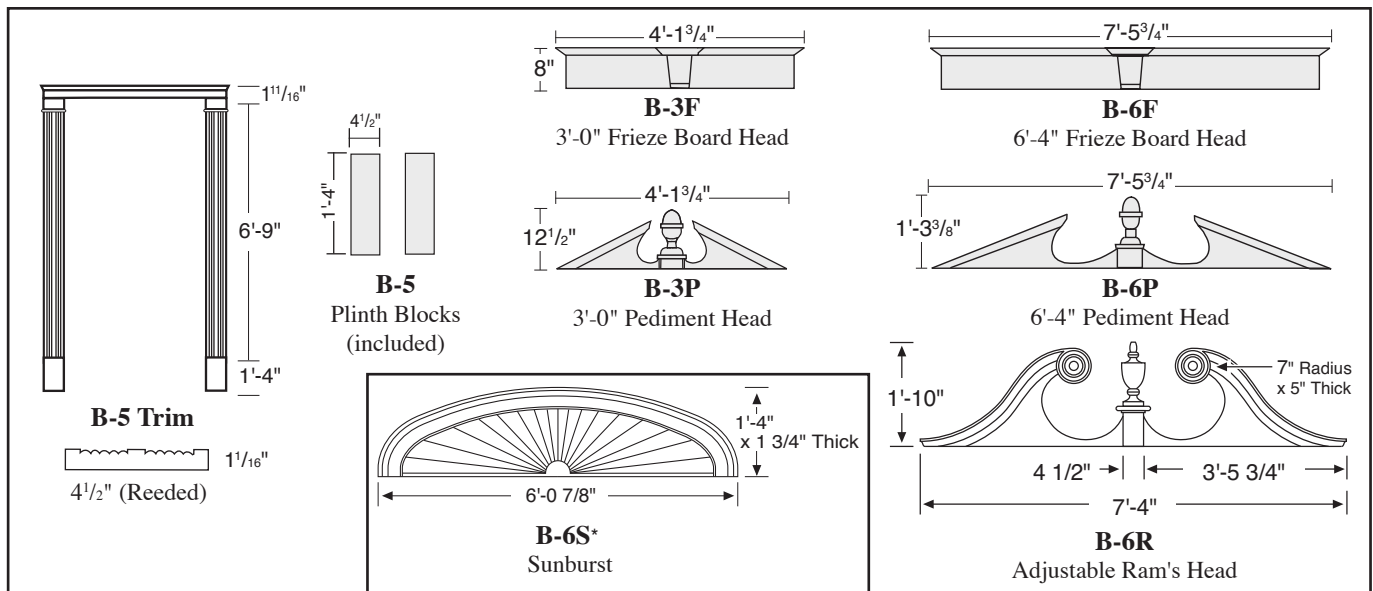

* B-6S Sunburst Head is compatible only with 3'-0" door with two 1'-0" sidelights and B-5 Trim.
For Individual Component Pricing - See Page E-2

B-6 Entrance Trim

- For Door Units up to 7'-0" in Height
- 2-1/4" Mullion Casing
- 5-1/2" Fluted Pilasters w/Plinth Blocks



Basic Trim
B-6
\$291.29

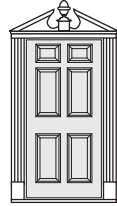

Basic Trim &
Pediment Head
\$525.59



Basic Trim &
Frieze Board Head
\$446.83



Basic Trim, Frieze Board &
Pediment Head
\$681.13

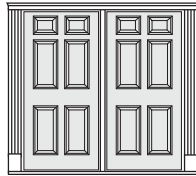

Basic Trim
B-6
\$397.32

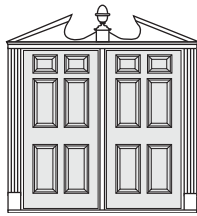

Basic Trim &
Pediment Head
\$718.76

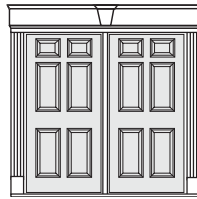

Basic Trim &
Frieze Board Head
\$632.54

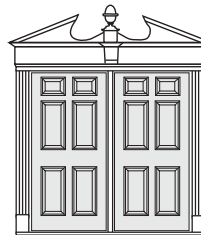

Basic Trim, Frieze Board &
Pediment Head
\$953.98

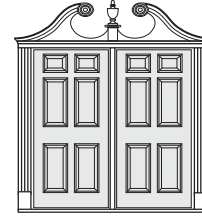

Basic Trim &
Ram's Head
\$1372.22

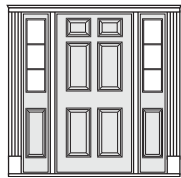

Basic Trim
B-6
\$397.32

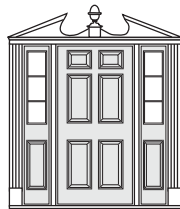

Basic Trim &
Pediment Head
\$718.76

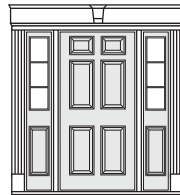

Basic Trim &
Frieze Board Head
\$632.54

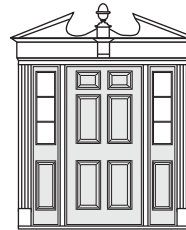

Basic Trim, Frieze Board &
Pediment Head
\$953.98



Basic Trim &
Ram's Head
\$1372.22

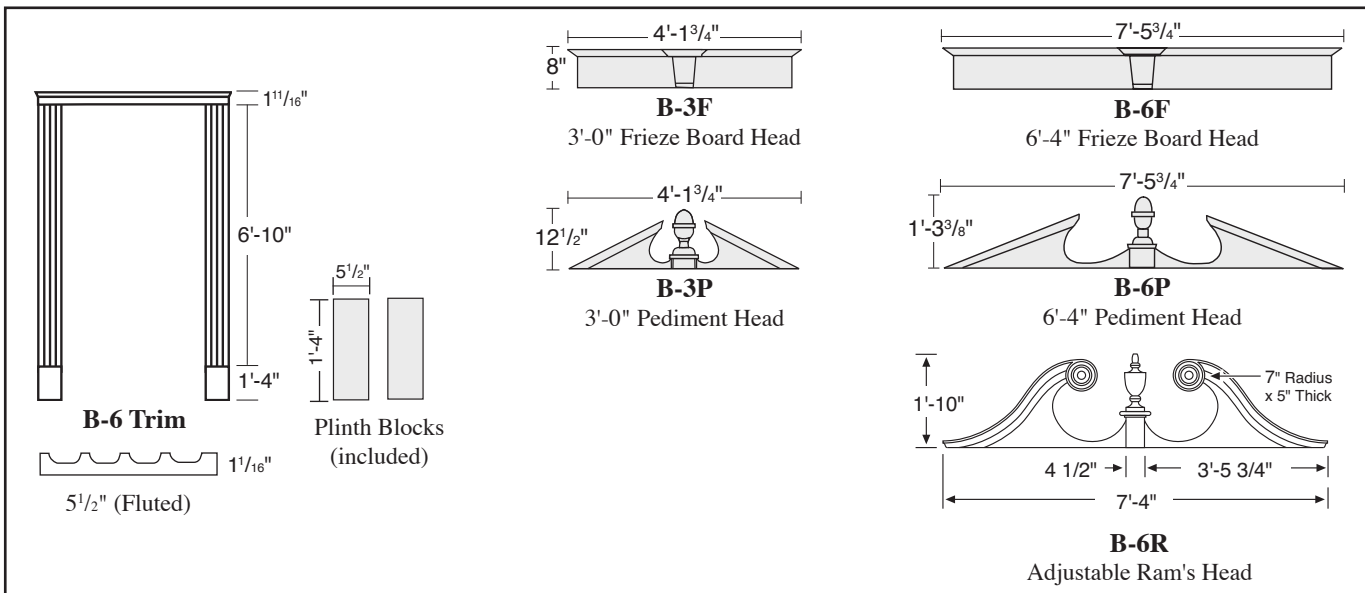

For Individual Component Pricing - See Page E-2

B-9 Entrance Trim

- For Door Units up to 7'-0" in Height
- 8-1/2" Fluted Pilasters
- 2-1/4" Mullion Casing



Basic Trim
B-9
\$444.78



Basic Trim &
Dentil Head
\$727.56

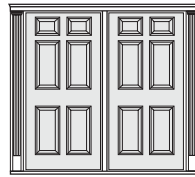

Basic Trim
B-9
\$528.51

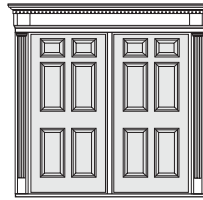

Basic Trim &
Dentil Head
\$1088.41

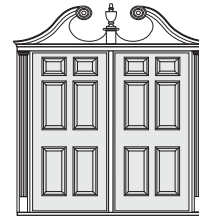

Basic Trim &
Ram's Head
\$1503.41

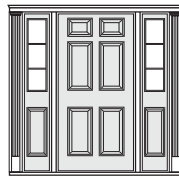

Basic Trim
B-9
\$528.51

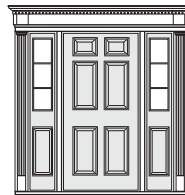

Basic Trim &
Dentil Head
\$1088.41



Basic Trim &
Ram's Head
\$1503.41

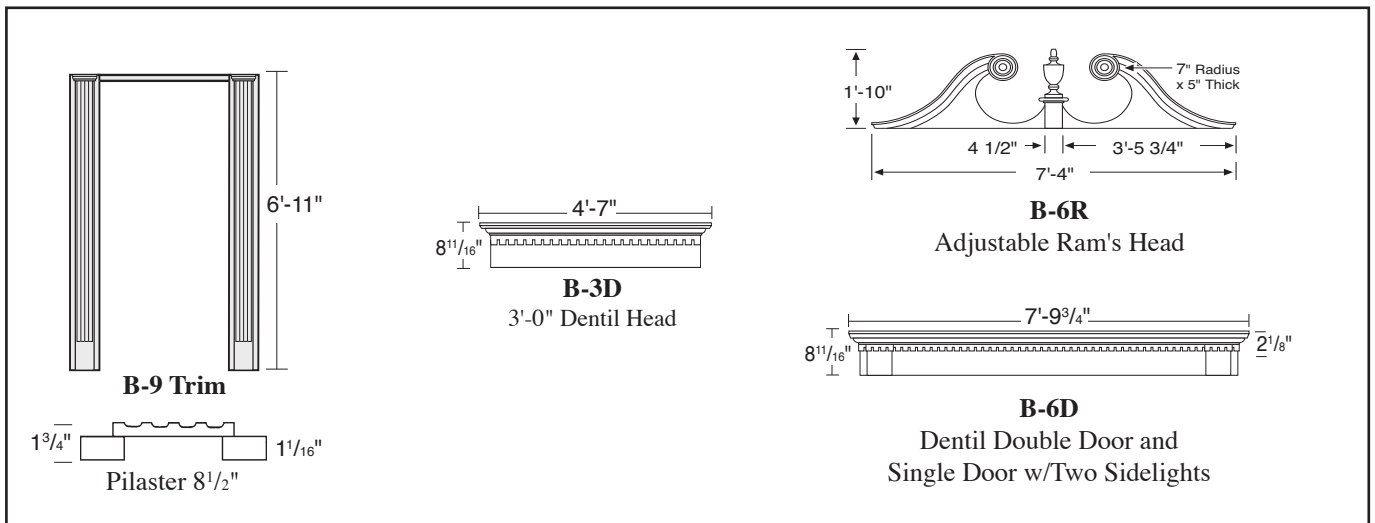

For Individual Component Pricing - See Page E-2

DETAILS

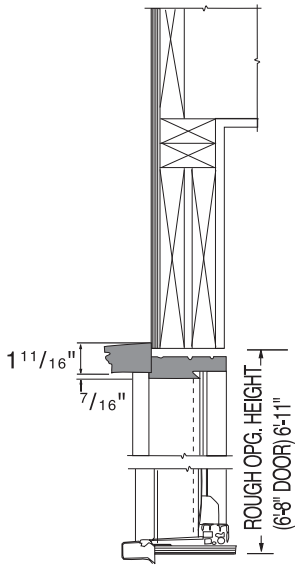

Basic Trim

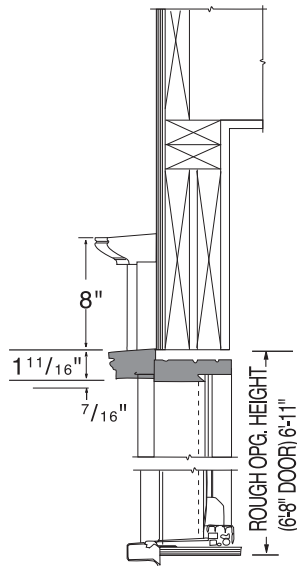

**Basic Trim
w/Frieze Board**

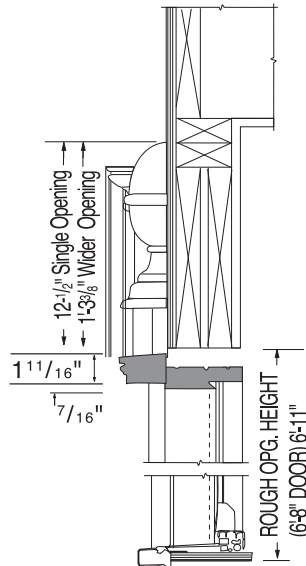

**Basic Trim
w/Pediment Head**

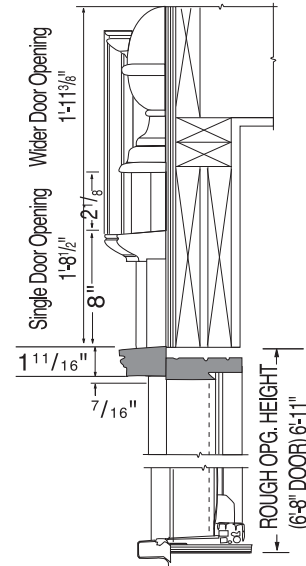

**Basic Trim
w/Pediment Head &
Frieze Board**

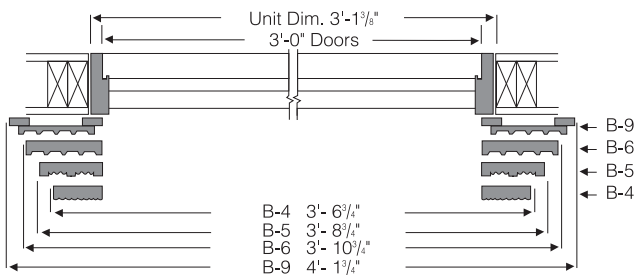

Single Door Unit

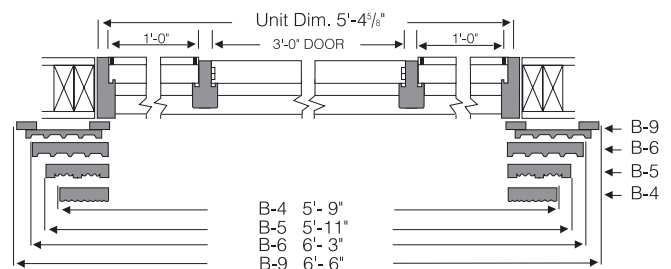

**Single Door with two 1'-0" Sidelights
(Mull post)**

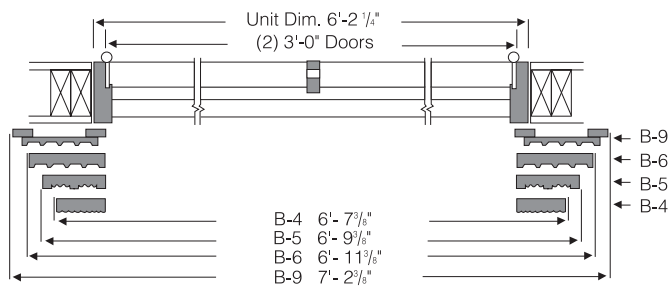

Double Door Unit

B-4, B-5, B-6 & B-9 Basic

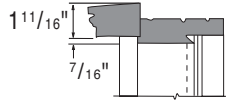
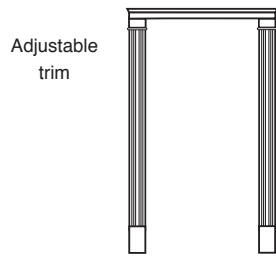

B-4 Pilaster
3 1/2" (Fluted)



B-5 Pilaster
4 1/2" (Reeded)
w/Plinth Blocks
(shown)



B-6 Pilaster
5 1/2" (Fluted)
w/Plinth Blocks



B-9 Pilaster
8 1/2" (Fluted)
w/Plinth Blocks

BASIC TRIM

Adjustability: The top shelf trim can be cut down if needed. Cut approximately 1 1/2" off from the end, then remove material needed for adjustment, glue and tack on the 1 1/2" end piece.

Cross blocks can be adjusted →

B-6D

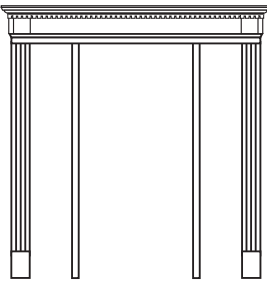

Due to adjustment, pilaster placement can vary for differing frame sizes.

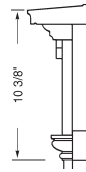

DENTIL HEAD

The cross blocks on the B-6D head can be placed to line up with the pilaster capital.

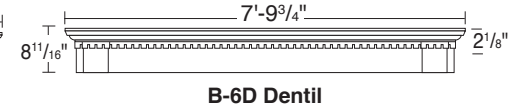
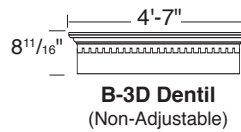

B-3F & B-6F

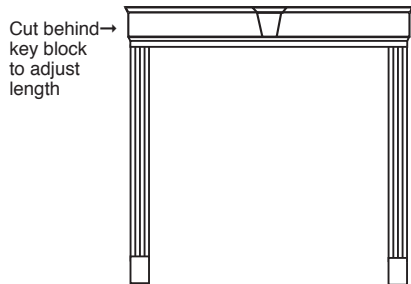

Frieze Board head can be adjusted by cutting the head backboard where it touches the finial base.

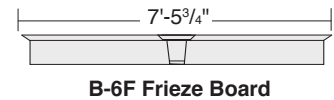
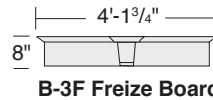
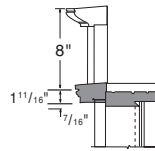

B-3F and B-6F FRIEZE BOARD HEAD

Adjustability: To adjust the frieze board head to your specific unit dimensions, cut directly behind the Key-Block. By removing material to the frieze board head then apply Key-Block.

B-3P & B-6P

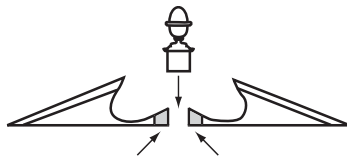

Cut equal amounts here to reduce size of pediment head

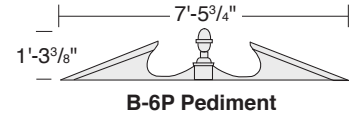
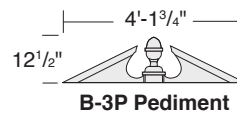
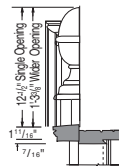

B-3P and B-6P PEDIMENT HEAD

Adjustability: The Pediment Head can be adjusted by cutting equal amounts off the backboard where it meets the finial base.

B-6R

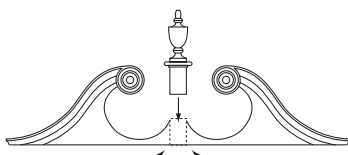

Cut equal amounts here to reduce size of ram's head

B-6R RAM'S HEAD

Adjustability: Ram's Head can be adjusted by cutting head back board at finial base. (Standard width of 88" accommodates up to a 3'-0" single door with two 1'-6" sidelights, or a 6'-0" double door. Minimum width for adjustment is 75" which will accommodate 3'-0" door units with two 10" sidelights, or a 5'-0" double door.)

NOTES: * Any adjustments are made on the job site at time of installation.

Date:
Copy:

Subject:	Page No.

COMMENTS

Notes

- 1.
- 2.
- 3.
- 4.
- 5.
- 6.
- 7.
- 8.
- 9.
- 10.
- 11.
- 12.
- 13.
- 14.
- 15.
- 16.
- 17.
- 18.
- 19.
- 20.
- 21.
- 22.
- 23.
- 24.
- 25.
- 26.
- 27.
- 28.
- 29.
- 30.
- 31.
- 32.