

Table of Contents:

Door Handing	OPT-1
Weather Out Flashing System.....	OPT-2
Primed Door Unit Jamb Options.....	OPT-2
Primed Door Unit Casing Options	OPT-3
Combination Storm Door Adapters	OPT-3
Cut-Down Doors	OPT-3
Sill Options	OPT-4
Miscellaneous Options	OPT-4
Hinge Options	OPT-5
Multi-Point Lock System	OPT-5
Custom SDL Capabilities.....	OPT-6 & OPT-7
Transom Options	OPT-8
Weatherstripping & Door Bottoms	OPT-9
Jamb & Sill Profiles.....	OPT-9
Rough Openings & Unit Dimensions.....	OPT-10
Exposure Protection	OPT-11

HOW TO DETERMINE HANDING

When the door opens toward you and the knob is on the left hand side, it is a LEFT HAND DOOR.
When the knob is on the right, it is a RIGHT HAND DOOR.

SINGLE DOOR

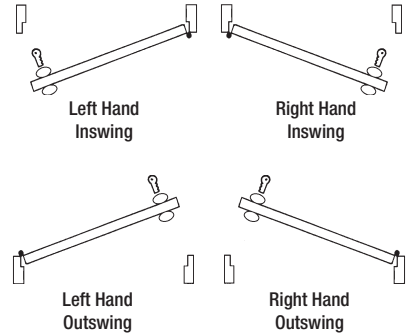

DOUBLE DOOR

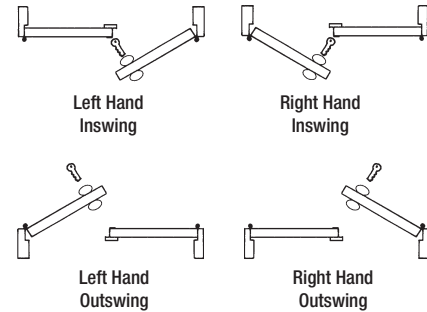

SINGLE DOOR w/Sidelight(s)

Handing is determined the same as a single door unit.
If ordering a unit with one sidelight, specify sidelight on hinge side or knob side.

JELD-WEN STAIN KIT

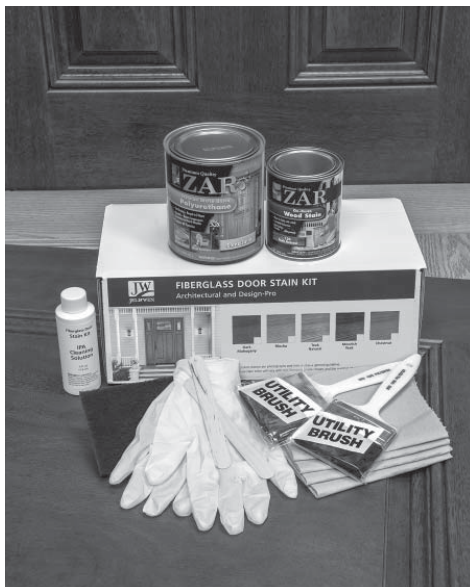

JELD-WEN Stain Kit includes:

- 1 - 4 oz. IPA Cleaner
- 1 - 16 oz. ZAR Stain
- 1 - 32 oz. ZAR Exterior Water-Based Polyurethane
- 2 - Synthetic Brushes
- 1 - Scuffing Pad
- 2 - Stain Cloths
- 2 - Cleaning Cloths
- 2 - Stir Sticks
- 1 - Pair Latex Gloves
- 1 - Door Staining Instructions



Stain Kit: \$137.00

Stain Kit Colors: Dark Mahogany, Mocha, Teak Natural, Moorish Teak, Chestnut



Options & Shop Services for Entry Units



Options in this section are adjustments for a PRIMED Basic Set-up Unit.

PRIMED DOOR UNIT JAMB OPTIONS:

(4-9/16" Primed Jamb w/Limited Lifetime Warranty included in Basic Unit)

		up to 7'-0" height Add to PRIMED FJ Basic Unit				8'-0" height Add to PRIMED FJ Basic Unit			
		Single	Double	Single w/1 SL	Single w/2 SL	Single	Double	Single w/1 SL	Single w/2 SL
Weather Out Flashing System - 4-9/16" Wall	ADD	\$ 23.70	\$ 31.60	\$ 31.60	\$ 39.50	\$ 23.70	\$ 31.60	\$ 31.60	\$ 39.50
Weather Out Flashing System - 6-9/16" Wall	ADD	25.80	34.40	34.40	43.00	25.80	34.40	34.40	43.00
Primed FJ Jamb - 4-9/16" Wall w/Limited Lifetime Warranty	ADD	Included	Included	Included	Included	Included	Included	Included	Included
Primed FJ Jamb - 5-1/4" Wall w/Limited Lifetime Warranty - 6'-8" only	ADD	28.00	35.00	42.00	84.00	-	-	-	-
Primed FJ Jamb - 6-9/16" Wall w/Limited Lifetime Warranty	ADD	31.00	43.00	53.00	97.00	48.00	95.00	92.00	136.00
Primed FJ Jamb - 8-1/8" Wall w/Limited Lifetime Warranty ‡	ADD	154.00	245.00	inquire	inquire	-	-	-	-
Primed FJ Jamb - 11-1/8" Wall w/Limited Lifetime Warranty ‡	ADD	265.00	320.00	inquire	inquire	-	-	-	-
Pine Jamb 4-9/16" Wall w/Limited Lifetime Warranty	ADD	50.00	49.00	84.00	135.00	106.00	140.00	188.00	250.00
Pine Jamb 5-1/4" Wall w/Limited Lifetime Warranty - 6'-8" only	ADD	146.00	150.00	227.00	288.00	-	-	-	-
Pine Jamb 6-9/16" Wall w/Limited Lifetime Warranty	ADD	130.00	133.00	172.00	264.00	119.00	183.00	228.00	288.00
FrameSaver Primed Jamb 4-9/16" Wall w/Lifetime Warranty	ADD	18.00	16.00	35.00	72.00	60.00	59.00	83.00	111.00
FrameSaver Primed Jamb 6-9/16" Wall w/Lifetime Warranty	ADD	81.00	91.00	120.00	196.00	107.00	134.00	166.00	201.00
FrameSaver Primed Jamb 9-1/4" Wall w/Lifetime Warranty ‡	ADD	248.00	289.00	inquire	inquire	-	-	-	-
Fir Engineered Jamb - 4-9/16" Wall	ADD	112.00	120.00	173.00	264.00	151.00	161.00	197.00	281.00
Fir Engineered Jamb - 6-9/16" Wall	ADD	274.00	390.00	424.00	532.00	375.00	436.00	442.00	582.00
Oak Jamb - 4-9/16" Wall	ADD	177.00	174.00	434.00	631.00	199.00	248.00	420.00	673.00
Oak Jamb - 6-9/16" Wall	ADD	284.00	306.00	553.00	767.00	285.00	452.00	561.00	832.00
Mahogany Jamb - 4-9/16" Wall	ADD	263.00	300.00	583.00	947.00	225.00	189.00	396.00	576.00
Mahogany Jamb - 6-9/16" Wall	ADD	413.00	499.00	761.00	1151.00	353.00	350.00	551.00	732.00
Composite Primed Jamb - 4-9/16" Wall	ADD	29.00	80.00	139.00	232.00	45.00	91.00	152.00	295.00
Composite Primed Jamb - 6-9/16" Wall	ADD	100.00	130.00	216.00	314.00	120.00	149.00	232.00	359.00
Composite White Cap Jamb - 4-9/16" Wall	ADD	42.00	105.00	174.00	282.00	65.00	129.00	204.00	372.00
Composite White Cap Jamb - 6-9/16" Wall	ADD	108.00	159.00	233.00	371.00	146.00	191.00	291.00	441.00
Composite Mahogany-Grained Jamb - 4-9/16" Wall	ADD	51.00	123.00	199.00	317.00	79.00	156.00	240.00	427.00
Composite Mahogany-Grained Jamb - 6-9/16" Wall	ADD	132.00	179.00	286.00	411.00	164.00	221.00	332.00	499.00
Rip Wood Jamb to other than specified wall size – Composite Jamb cannot be ripped	ADD	26.00	42.00	47.00	52.00	26.00	42.00	47.00	52.00
NVD FRAMES									
Mahogany/Cherry NVD Jamb - 4-9/16" Wall	ADD	154.00	130.00	336.00	522.00	161.00	151.00	337.00	538.00
Mahogany/Cherry NVD Jamb - 6-9/16" Wall	ADD	227.00	221.00	469.00	705.00	255.00	281.00	513.00	786.00
Fir NVD Jamb - 4-9/16" Wall	ADD	154.00	130.00	336.00	522.00	-	-	-	-
Fir NVD Jamb - 6-9/16" Wall	ADD	227.00	221.00	469.00	705.00	-	-	-	-
Oak/Alder NVD Jamb - 4-9/16" Wall	ADD	154.00	130.00	336.00	522.00	161.00	151.00	337.00	538.00
Oak/Alder NVD Jamb - 6-9/16" Wall	ADD	227.00	221.00	469.00	705.00	255.00	281.00	513.00	786.00

Mullion Posts for Sidelight Units are always the same species as the jamb.

ASTRAGAL OPTIONS:

(Standard Double Door Unit includes White Aluminum Ultimate Flip Astragal included in Basic Unit)

			6'-6" Ht.	6'-8" Ht.	7'-0" Ht.	8'-0" Ht.
Change to Veneered Ultimate Flip Astragal:	- Pine, Fir, Oak Mahogany	ADD	-	\$ 70.00	\$ 76.00	\$ 76.00
Change to Multi-Point Ultimate Astragal	- White	ADD	-	203.00	207.00	207.00
Unique Aluminum Astragal has three points where it latches into the active door. Flip Lever to activate Flush Bolts.	- Pine or Oak Veneered	ADD	-	285.00	-	-
Functions with standard deadbolt latch.	- Fir Veneered	ADD	\$285.00	285.00	301.00	301.00
	- Mahogany Veneered	ADD	-	285.00	-	301.00
Change to Wood Astragal	- Primed	DEDUCT	-	-90.00	-	-
Flush Bolts -	- Pine	DEDUCT	-	-68.00	-	-99.00
Brass, Bronze, Polish Chrome & Satin Nickel	- Fir	DEDUCT	-	-65.00	-	-80.00

CLAD-PLUS II VINYL (FRAME & BRICKMOULD) – INSWING ONLY

Exterior surfaces are Vinyl Clad, Interior surfaces feature high quality prime finish to accommodate the matching of interior décor.

	6'-8"		6'-8"		CLAD-PLUS II WITH SIDELIGHTS ARE COMPATIBLE WITH ALUMINUM SILL ONLY.
	Single	Double	Single w/1 sdlts	Single w/2 sdlts	
4-9/16"	\$ 96.00	\$200.00	\$220.00	\$269.00	
6-9/16"	170.00	323.00	308.00	365.00	

BROSCO Set-up Open Frame (Based on Basic FJP Unit specs)		
Basic Unit Single		
6'-8"	7'-0"	8'-0"
\$197.00	\$209.00	\$296.00

‡ Jamb over 6⁹/₁₆" with Aluminum Sill – appropriate sill extenders included (Satin Nickel 4⁹/₁₆", 6⁹/₁₆" only).

**Double Door = Single Door unit times 2 plus \$113.00 (4⁹/₁₆" Wall)
Includes White Aluminum Ultimate Flip Astragal**

Options in this section are adjustments for a PRIMED Basic Set-up Unit.

PRIMED DOOR UNIT CASING OPTIONS:
(Price includes appropriate Sill Horns)

		up to 7'-0" height Add to PRIMED FJ Basic Unit				8'-0" height Add to PRIMED FJ Basic Unit			
		Single	Double	Single w/1 SL	Single w/2 SL	Single	Double	Single w/1 SL	Single w/2 SL
Primed Flat Casing									
1-1/16" x 3-1/2"	ADD	\$ 22.00	\$ 24.00	\$ 26.00	\$ 25.00	\$ 36.00	\$ 38.00	\$ 49.00	\$ 44.00
11/16" x 4-1/2" Cape Cod *	ADD	51.00	53.00	53.00	58.00	50.00	52.00	50.00	55.00
1-1/16" x 5-1/4" Head & Sides	ADD	110.00	123.00	123.00	128.00	109.00	122.00	127.00	132.00
1-1/16" x 5-1/4" Head with 1-1/16" x 3-1/2" Sides	ADD	31.00	44.00	44.00	44.00	45.00	58.00	67.00	63.00
1-1/16" x 7-1/4" Head with 1-1/16" x 3-1/2" Sides	ADD	48.00	79.00	79.00	99.00	62.00	93.00	102.00	118.00
FrameSaver Primed Brickmould	ADD	21.00	33.00	37.00	42.00	17.00	29.00	29.00	29.00
FrameSaver Primed Flat	ADD	69.00	74.00	84.00	89.00	70.00	75.00	81.00	82.00
Pine Brickmould	ADD	25.00	30.00	30.00	27.00	25.00	30.00	30.00	27.00
Pine Flat Casing 1-1/16" x 3-1/2"	ADD	60.00	72.00	72.00	70.00	-	-	-	-
Fir Brickmould	ADD	63.00	74.00	74.00	77.00	47.00	58.00	63.00	61.00
Fir Flat Casing 1-1/16" x 3-1/2"	ADD	125.00	148.00	148.00	150.00	97.00	120.00	125.00	122.00
Oak Brickmould	ADD	99.00	118.00	118.00	145.00	140.00	159.00	164.00	186.00
Oak Flat Casing 1-1/16" x 3-1/2"	ADD	113.00	135.00	135.00	160.00	186.00	208.00	213.00	233.00
Mahogany Brickmould	ADD	174.00	208.00	208.00	214.00	151.00	185.00	190.00	191.00
Mahogany Flat Casing 1-1/16" x 3-1/2"	ADD	336.00	402.00	403.00	417.00	313.00	379.00	385.00	394.00
Cedar Flat Casing 1-1/16" x 3-1/2"	ADD	195.00	234.00	234.00	210.00	-	-	-	-
PVC Brickmould (White)	ADD to Wood Frame only	53.00	51.00	51.00	51.00	52.00	50.00	50.00	50.00
PVC Brickmould (White) w/J-Channel	ADD to Wood Frame only	64.00	74.00	74.00	74.00	58.00	68.00	68.00	68.00
PVC Flat (White) 1" x 3-1/2"	ADD to Wood Frame only	110.00	130.00	134.00	137.00	172.00	192.00	191.00	196.00
PVC Flat (White) 1-1/8" x 3-1/2" w/J-Channel	ADD to Wood Frame only	121.00	144.00	144.00	145.00	212.00	235.00	240.00	236.00
Composite Primed Brickmould	ADD	25.00	30.00	30.00	30.00	39.00	44.00	49.00	51.00
Composite Primed Flat Casing 1-1/16" x 3-1/2"	ADD	82.00	115.00	115.00	115.00	86.00	119.00	118.00	118.00
Composite White Cap Brickmould	ADD	30.00	36.00	36.00	36.00	48.00	54.00	59.00	63.00
Composite White Cap Flat Casing 1-1/16" x 3-1/2"	ADD	90.00	126.00	126.00	131.00	101.00	137.00	138.00	134.00
Composite Mahogany-Grained Brickmould	ADD	38.00	45.00	45.00	45.00	66.00	73.00	73.00	73.00
NVD – Cherry, Mahogany, Oak, Alder Brickmould		91.00	108.00	146.00	186.00	69.00	86.00	137.00	179.00
NVD – Fir Flat	ADD	123.00	146.00	183.00	224.00	-	-	-	-
DEDUCT for No Primed Brickmould (3-1/2" Sill Horns)	DEDUCT	-14.00	-17.00	-17.00	-22.00	-47.00	-50.00	-45.00	-55.00

COMBINATION STORM DOOR ADAPTER:

	FJP Up to 7'-0" Ht. Applied (each post)	Clear Pine Up to 7'-0" Ht. Applied (each post)	Clad Plus II ** 6'-8" Ht. Applied (each post)	FrameSaver Up to 7'-0" Ht. Applied (each post)
4-9/16" Jamb	\$ 41.00	\$ 47.00	\$ 44.00	\$ 53.00
6-9/16" Jamb	105.00	117.00	102.00	133.00

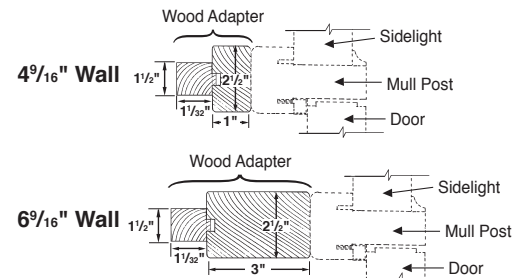

Architectural, Design-Pro & Smooth-Pro Fiberglass Doors & Sidelights • Contours & Gladiator Steel Doors & Sidelights

CUT-DOWN DOORS:

As a standard, the first cut will always be off the bottom of the door (this will lower the lock bore & hinge location)

	Single	Double	Each Sidelight
Fiberglass & Steel and All Direct Glaze (Minimum cut on Steel doors 1/2")			
For one cut (up to 4")	ADD \$ 65.00	\$ 130.00	\$ 65.00
For two cuts (over 4" up to 9")	ADD 130.00	260.00	130.00
Design-Pro & Smooth-Pro - Flush Designs, 100, 412, 636, 696, 919			
Steel - Flush Designs, 100, 412, 636, 686, 696, 919 (Minimum cut on Steel doors 1/2")			
For one cut (up to 6")	ADD 65.00	130.00	65.00
For two cuts (over 6" up to 9")	ADD 130.00	260.00	130.00
Cut Frame Height	Single	Double	Single w/1 SL Double w/2 SL
To height other than 6'-6", 6'-8", 7'-0" or 8'-0"	ADD \$16.00	\$42.00	\$26.00 \$42.00

20 & 90-Minute Fire Doors are not applicable to this fee – Special order

NOTES: * BROSCO Combination Doors (1-1/16" thick) are not compatible with Cape Cod Casing (11/16" thick).
** Clad Plus II Storm Door Adapters are compatible with Clad Plus II Frames only.



Options & Shop Services for Entry Units



SILL OPTIONS:

(Aluminum Sill Adjustable-Inswing, Mill Finish w/Sill Horns included in Basic Unit)

All BROSCO sills feature 3-1/2" horns as standard. Aluminum sill also features a protective sill cover.

		Add to PRIMED FJ Basic Unit			
		Single	Double	Single w/1 SL	Single w/2 SL
Aluminum Sill - Mill Finish (Adjustable-Inswing) with 3-1/2" Sill Horns	ADD	Included	Included	Included	Included
Bronze, Brass or Satin Nickel* Finish Aluminum Sill (Adjustable-Inswing) w/Horns	ADD	\$ 22.00	\$ 42.00	\$ 32.00	\$ 44.00
Long Sill Horns - Aluminum - Inswing or Outswing - up to 12"	ADD	25.00	25.00	35.00	35.00
<i>New!</i> Composite Aluminum Sill - Mill Finish (Adjustable-Inswing) with 3-1/2" Sill Horns - 4-9/16" & 5-1/4" wall	ADD	6.00	19.00	15.00	34.00
- 6-9/16" wall	ADD	7.00	28.00	21.00	38.00
Bronze Finish Composite Aluminum Sill - Bronze Finish (Adjustable-Inswing) with 3-1/2" Sill Horns	ADD	26.00	59.00	47.00	78.00
- 4-9/16" & 5-1/4" wall	ADD	27.00	68.00	53.00	82.00
- 6-9/16" wall	ADD				
Oak Sill - Laminated - Inswing - with 3-1/2" Sill Horns - 4-9/16" & 5-1/4" wall	ADD	22.00	68.00	96.00	140.00
- 6-9/16" wall	ADD	35.00	77.00	141.00	155.00
Oak Sill - Laminated - Inswing - up to 12" Sill Horns - 4-9/16" & 5-1/4" wall	ADD	72.00	118.00	188.00	301.00
- 6-9/16" wall	ADD	85.00	127.00	231.00	377.00
Oak Sill - Solid Base w/Laminated Threshold - Inswing - up to 12" Horns (8'-0" Max) - 4-9/16" & 5-1/4" wall	ADD	165.00	169.00	175.00	189.00
- 6-9/16" wall	ADD	170.00	183.00	181.00	205.00
White Oak Sill - 4-9/16" & 5-1/4" wall	ADD	99.00	201.00	158.00	185.00
- 6-9/16" wall	ADD	145.00	247.00	189.00	223.00
Mahogany Sill - Solid - Inswing - 3-1/2" Sill Horns - 4-9/16" & 5-1/4" wall	ADD	126.00	300.00	217.00	231.00
- 6-9/16" wall	ADD	160.00	371.00	250.00	264.00
Mahogany Sill - Solid - Inswing - up to 12" Sill Horns - 4-9/16" & 5-1/4" wall	ADD	207.00	325.00	261.00	385.00
- 6-9/16" wall	ADD	239.00	396.00	336.00	491.00
Outswing Unit (includes 3 non-removable pin hinges per slab - Zinc Dichromate w/Mill Aluminum Sill)	ADD	25.00	50.00	25.00	25.00
Outswing Double Door Unit Security Flange	ADD	-	46.00	-	-
Oak Sill - Laminated - Outswing - up to 12" Sill Horns (8'-0" max) - 4-9/16" & 5-1/4" wall	ADD	69.00	112.00	148.00	162.00
- 6-9/16" wall	ADD	82.00	146.00	163.00	177.00
Mahogany Sill - Laminated - Outswing - up to 12" Sill Horns (8'-0" max) - 4-9/16" & 5-1/4" wall	ADD	192.00	318.00	214.00	294.00
- 6-9/16" wall	ADD	229.00	385.00	421.00	474.00
Public Access Sill - Aluminum with Thermal-Break (applied) - Maximum 7 ⁵ / ₈ " Sill Width (6'-0" max)					
Mill Finish - 4-9/16" & 5-1/4" wall	ADD	14.00	33.00	37.00	51.00
- 6-9/16" wall	ADD	14.00	33.00	37.00	51.00
Bronze Finish - 4-9/16" & 5-1/4" wall	ADD	37.00	67.00	78.00	92.00
- 6-9/16" wall	ADD	40.00	111.00	109.00	137.00

Extra Wide Wall Aluminum Sill Extender (not applied): 12'-0" piece only

3/16" thick aluminum to extend a 6-9/16" wall sill up to 11-1/2". Field application is required.

Mill Finish

Bronze Finish

\$130.00

\$174.00



Door Viewer



Mailslot

MISCELLANEOUS OPTIONS:

DEADBOLT PREP - § Must specify "BROSCO jamb prep or no jamb prep" - 2-1/8" or 1-1/2" Facebore - 5-1/2" on center above lock	ADD	\$ 11.00
BROSCO Lockguard Security Plate applied	ADD	13.00
Mortise Lock Prep (1) (Lock or template must be supplied) - check with BROSCO for design compatibility		
Prep with no Function Holes	ADD	95.00
Prep with Function Holes	ADD	189.00
Install Door Viewer (UL) (1 installed in active door - 5'-0" from bottom of door) - ADD to price of door viewer		16.00
Door Viewer - 115°		
- Bright Brass US3	ADD	7.00
- Dark Bronze US10R • Satin Nickel US15 • Satin Chrome US26D	ADD	11.00
Prep Door for Mailslot (1) - (Overall Size 13" x 3-3/4") - ADD to price of mailslot		37.00
Mailslot - with Stainless Steel Sleeve - Magazine Size (Plate Opening 11" x 2") - not installed		
- Bright Brass US3	ADD	146.00
- Aged Bronze • Satin Nickel US15 • Satin Chrome US26D	ADD	171.00
Kickplate - Bright Brass 6" x 34" (for 3'-0" doors) - not applied	ADD	56.00
Magnetic Weatherstrip applied - TAN color 6'-8" & 7'-0"	ADD	
Magnetic Weatherstrip applied - TAN color 8'-0"	ADD	
		Single Double
		\$23.00 \$26.00
		26.00 29.00
Bronze Weatherstrip standard on all frames except Clad & Composite White Cap which come with white weatherstrip		
Non-standard color weatherstrip	ADD	12.00

NOTES: § BROSCO jamb prep = 1-1/8" x 2-3/4" (RC) with extra 1/8" depth for jamb reinforcer.

* Satin Nickel Aluminum Sill 4⁹/₁₆" and 6⁹/₁₆" Wall only.



Options & Shop Services for Entry Units



Options in this section are adjustments for a Basic Set-up Unit.

HINGE OPTIONS: Zinc Dichromate Finish Hinges included in Basic Unit (Square / Radius).

	6'-8" height		8'-0" height		
	Single Door	Double Door	Single Door	Double Door	
Square / Radius Hinges - Plain Bearing - Inswing Bright Brass US3 • Antique Brass US5 • Dark Bronze US10R • Antique Nickel US15A Satin Nickel US15 • Black US1D	ADD	\$ 5.00	\$ 10.00	\$ 10.00	\$ 20.00
Solid Brass A-US3	ADD	61.00	122.00	95.00	190.00
Outswing NRP Hinges (3) - Plain Bearing (Zinc Dichromate included in outswing) Square / Radius - Bright Brass US3 • Antique Brass US5 • Dark Bronze US10R Antique Nickel US15A • Satin Nickel US15	ADD	10.00	20.00	14.00	28.00
Radius / Radius - Stainless Steel NRP Hinges	ADD	45.00	90.00	61.00	122.00
Outswing NRP Hinge(s) Plus Spring Hinges (2) - Square / Radius - Plain Bearing Zinc Dichromate US2D	ADD	11.00	22.00	17.00	34.00
Bright Brass US3 • Antique Brass US5 • Dark Bronze US10R Antique Nickel US15A • Satin Nickel US15	ADD	24.00	48.00	24.00	48.00
Spring Hinges (2) - Square / Radius - Inswing Zinc Dichromate US2D	ADD	16.00	32.00	19.00	38.00
Bright Brass US3 • Antique Brass US5 • Dark Bronze US10R Antique Nickel US15A • Satin Nickel US15 • Black US1D	ADD	19.00	38.00	22.00	44.00
Square Spring Hinges (2) - Inswing Dark Bronze US10R • Satin Nickel US15	ADD	53.00	106.00	47.00	94.00
Radius Hinges - Plain Bearing - Inswing Bright Brass US3 • Satin Brass US4 • Antique Brass US5 • Antique Bronze Lacquered US10A Dark Bronze US10R • Antique Nickel US15A • Satin Nickel US15 • Satin Chrome US26D Polished Chrome US26D • Black US1D • White Primed WP	ADD	5.00	10.00	10.00	20.00
Light Brass 3LB		<i>No additional charge</i>			
Solid Brass A-US3	ADD	39.00	78.00	57.00	114.00
Stainless Steel US32D (fixed pin)	ADD	45.00	90.00	61.00	122.00
Ball-Bearing - Radius / Radius - Inswing Zinc Dichromate US2D • Bright Brass US3 • Antique Brass US5 • Dark Bronze US10R Antique Nickel US15A • Satin Nickel US15 • Satin Chrome US26D Polished Chrome US26 • Black US1D	ADD	18.00	36.00	26.00	52.00
Square Plain Bearing Bright Brass US3 • Antique Brass US5 • Dark Bronze US10R • Antique Nickel US15A Satin Nickel US15 • Satin Chrome US26D • Polished Chrome US26 • Black US1D	ADD	16.00	32.00	23.00	46.00
Square Ball-Bearing Zinc Dichromate US2D • Bright Brass US3 • Satin Brass US4 • Antique Brass US5 Antique Bronze Lacquered US10A • Dark Bronze US10R • Antique Nickel US15A Satin Nickel US15 • Satin Chrome US26D • Polished Chrome US26	ADD	23.00	46.00	32.00	64.00
BALDWIN SOLID BRASS HINGES - Square - Inswing (All Baldwin Hinges include Button Tips)					
Plain Bearing - Lifetime Solid Bright Brass 003	ADD	\$195.00	\$390.00	\$260.00	\$520.00
Plain Bearing - Solid Bright Brass 030 • Antique Brass 050 • Satin Brass/Brown 060 Oil-Rubbed Bronze 102 • Satin Nickel 150 • Polished Chrome 260	ADD	157.00	314.00	209.00	418.00
Ball Bearing - Lifetime Solid Bright Brass 003	ADD	229.00	458.00	306.00	612.00
Ball Bearing - Solid Bright Brass 030 • Antique Brass 050 • Oil-Rubbed Bronze 102 Satin Nickel 150 • Polished Chrome 260	ADD	191.00	382.00	255.00	510.00
BALDWIN SOLID BRASS FINIALS (Tips)					
Lifetime Solid Brass 003 (Urn & Steeple - <i>factory order</i>)	ADD	\$58.00	\$116.00	\$73.00	\$146.00
Solid Bright Brass 030 • Oil-Rubbed Bronze 102 • Antique Brass 050 (Ball & Urn Tips Only) Polished Chrome 260 (Urn - <i>factory order</i>) • Satin Nickel 150 (Urn, Acorn & Steeple - <i>factory order</i>)	ADD	50.00	100.00	64.00	128.00
Convert a Standard Hinge to "Non-Removable Pin" ADD \$26.00 each hinge					

MULTI-POINT LOCK SYSTEMS

Lock mechanism is installed - Handle Trim & Latch shipped loose.



		F77-R Polished Brass	F42R Satin Nickel	F8709 Rustic Umber**
München 3955	Active	\$538.00	\$616.00	\$570.00
	Dummy	179.00	250.00	-
München 3965	Active	538.00	616.00	570.00
	Dummy	179.00	250.00	208.00
Verona 3955	Active	570.00	609.00	570.00
	Dummy	223.00	244.00	-
Verona 3965	Active	538.00	616.00	570.00
	Dummy	-	250.00	208.00

Add for 7'-0" Door Ht.	\$7.00	Add for 8'-0" Door Ht.	\$19.00
------------------------	--------	------------------------	---------

**Rustic Umber is similar to Oil-Rubbed Bronze finish.

When ordering please specify Handle, Escutcheon Plate and Function.

Handle: München or Verona
Escutcheon Plate: 3955 or 3965
Function: Active or Dummy

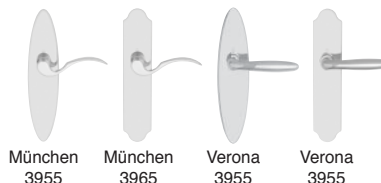

BALDWIN Solid Brass Finial (Tips)

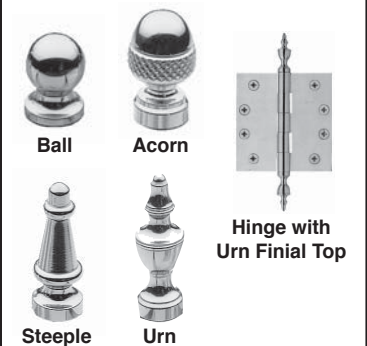

NOTE: Items priced in *italics* are factory order – please allow additional lead time.

Custom SDL Capabilities

Simulated Divided Lights add an attractive aesthetic to any fiberglass and steel entry door unit. Adheres directly on the surface of the glass, giving your door a truly traditional appearance.

- ✓ *Any Door*
- ✓ *Any Configuration*
- ✓ *Any Style*

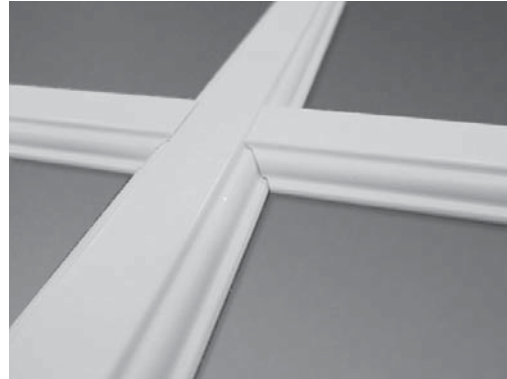

If you can dream it... we can make it!

- 1-1/8" Straight Contoured SDL Bars
 - White, Mahogany, Oak/Fir
- Black 3M VHB Adhesive creates shadow effect
- Coped to match grille and frame profile
- Available for all JELD-WEN® Door Families
 - Doors & Sidelights, including Craftsman & Beadboard
 - Direct Glaze and Standard Door Lights
 - Clear and Low-E

\$30 List per Light
(Add to Door Unit)



Not all configurations available in all door families.
Custom configurations also available, call BROSCO.

BUILT BY

SDL Layouts

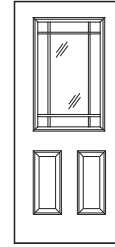
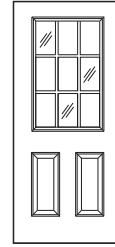
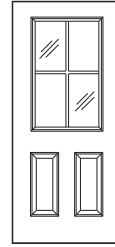
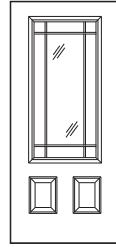
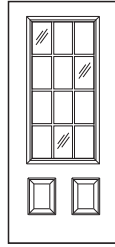
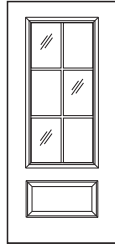
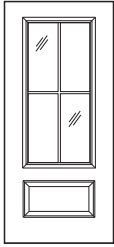

607 4-Light \$120.00	607 6-Light \$180.00	607 12-Light \$360.00	607 Prairie \$270.00	684 4-Light \$120.00	684 9-Light \$270.00	684 Prairie \$270.00
--------------------------------	--------------------------------	---------------------------------	--------------------------------	--------------------------------	--------------------------------	--------------------------------

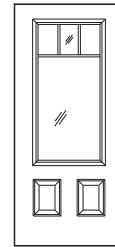
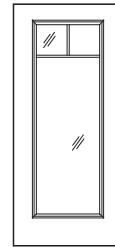
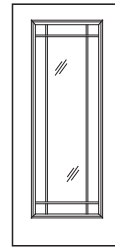
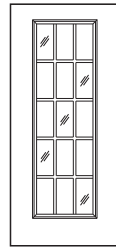
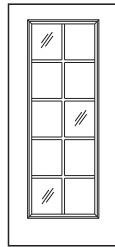
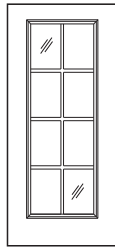
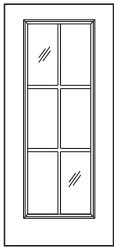

686 6-Light \$180.00	686 8-Light \$240.00	686 10-Light \$300.00	686 15-Light \$450.00	686 Prairie \$270.00	AC 3-Light \$90.00	AC 4-Light \$120.00
--------------------------------	--------------------------------	---------------------------------	---------------------------------	--------------------------------	------------------------------	-------------------------------

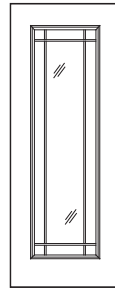
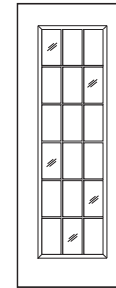
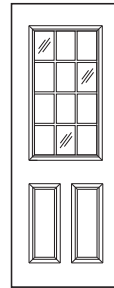
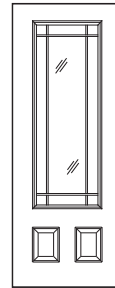
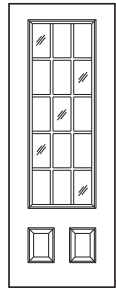
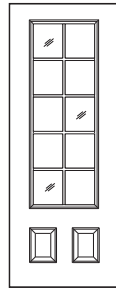
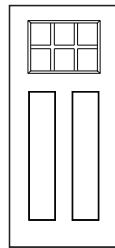
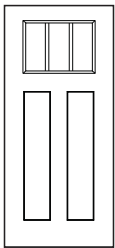

866 3-Light \$90.00	866 6-Light \$180.00	8-607 10-Light \$300.00	8-607 15-Light \$450.00	8-607 Prairie \$270.00	8-684 12-Light \$360.00	8-686 12-Light \$540.00	8-686 Prairie \$270.00
-------------------------------	--------------------------------	-----------------------------------	-----------------------------------	----------------------------------	-----------------------------------	-----------------------------------	----------------------------------

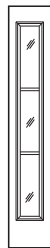
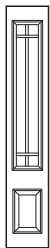
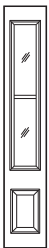

422 2-Light \$60.00	422 3-Light \$90.00	422 4-Light \$120.00	422 Prairie \$180.00	690 3-Light \$90.00	690 4-Light \$120.00	690 5-Light \$150.00	690 Prairie \$180.00	692 3-Light \$90.00	692 Prairie \$180.00
-------------------------------	-------------------------------	--------------------------------	--------------------------------	-------------------------------	--------------------------------	--------------------------------	--------------------------------	-------------------------------	--------------------------------

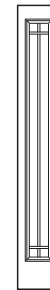
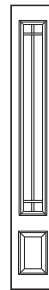
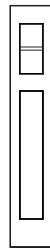
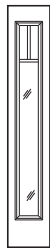

AC 3-Light \$90.00	820 2VLT \$60.00	820 2HLT \$60.00	8-422 5-Light \$150.00	8-422 Prairie \$180.00	8-690 6-Light \$180.00	8-690 Prairie \$180.00	8-692 4-Light \$120.00	8-692 Prairie \$180.00
------------------------------	----------------------------	----------------------------	----------------------------------	----------------------------------	----------------------------------	----------------------------------	----------------------------------	----------------------------------



Options & Shop Services for Entry Units



TRANSOM OPTIONS

Elliptical, Segment & Round Top Transoms – when selecting optional frame species, matching Brickmould is included.



Elliptical



Segment

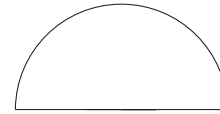

Round Top

TRANSOM ACCESSORIES			Elliptical Transom	Segment Transom	Round Top Transom	
			502, 503, 512, 514	532	500	515, 516
Jamb Options	Pine	ADD	\$ 10.00	\$ 10.00	\$ 10.00	\$ 10.00
	Oak (Veneered)	ADD	37.00	27.00	14.00	104.00
	Mahogany (Veneered)	ADD	719.00	815.00	713.00	840.00
Flat Exterior Casing 1-1/16" x 3-1/2"	Primed	ADD	47.00	47.00	68.00	56.00
	Pine	ADD	47.00	47.00	68.00	56.00
	Oak (Veneered)	ADD	71.00	75.00	66.00	101.00
	Mahogany (Veneered)	ADD	266.00	281.00	267.00	296.00
2-1/2" Colonial Casing WM351	Pine	ADD	174.00	174.00	181.00	234.00
	Oak	ADD	185.00	185.00	189.00	253.00
	Mahogany	ADD	446.00	446.00	446.00	517.00
3-1/2" Colonial Casing WM444	Pine	ADD	201.00	201.00	204.00	272.00
	Oak	ADD	215.00	215.00	219.00	296.00
	Mahogany	ADD	573.00	573.00	573.00	660.00
6-9/16" Wall Extension Jamb	Pine	ADD	196.00	227.00	172.00	229.00
	Oak	ADD	207.00	241.00	199.00	243.00
	Mahogany	ADD	253.00	342.00	246.00	319.00

RECTANGULAR TRANSOM JAMB OPTIONS:

Up to 3'-0" WIDTH	Primed FJ	Pine	Fir	Oak	Mahogany
4-9/16" Wall	Included	\$13.00	\$ 37.00	\$ 98.00	\$130.00
6-9/16" Wall	\$24.00	20.00	155.00	148.00	205.00
Over 3'-0" WIDTH					
4-9/16" Wall	Included	34.00	87.00	207.00	226.00
6-9/16" Wall	52.00	53.00	310.00	322.00	347.00

RECTANGULAR TRANSOM CASING OPTIONS:

If the exterior casing is to be applied to the entire unit with a Rectangular Transom, ADD the following to the Basic Door Unit with no casing.

		up to 7'-0" height Add to PRIMED FJ Basic Unit				8'-0" height Add to PRIMED FJ Basic Unit			
		Single	Double	Single w/1 SL	Single w/2 SL	Single	Double	Single w/1 SL	Single w/2 SL
Primed Brickmould	ADD	\$ 70.00	\$ 73.00	\$ 73.00	\$ 78.00	\$ 70.00	\$ 73.00	\$ 73.00	\$ 78.00
Primed Flat Casing 1-1/16" x 3-1/2"	ADD	112.00	117.00	119.00	123.00	112.00	117.00	119.00	123.00
Primed Cape Cod Flat 11/16" x 4-1/2"	ADD	95.00	100.00	101.00	101.00	95.00	100.00	101.00	101.00
Primed Flat 1-1/16" x 5-1/4" Head & Sides	ADD	179.00	195.00	195.00	200.00	179.00	195.00	195.00	200.00
Pine Brickmould	ADD	102.00	110.00	110.00	112.00	102.00	110.00	110.00	112.00
Fir Brickmould - (6'-8" Only)	ADD	97.00	111.00	111.00	119.00	-	-	-	-
Fir Flat Casing 1-1/16" x 3-1/2" - (6'-8" Only)	ADD	162.00	188.00	188.00	195.00	-	-	-	-
Oak Flat Casing 1-1/16" x 3-1/2"	ADD	227.00	252.00	252.00	282.00	227.00	252.00	252.00	282.00
Mahogany Brickmould	ADD	203.00	240.00	240.00	251.00	203.00	240.00	240.00	251.00
Mahogany Flat Casing 1-1/16" x 3-1/2"	ADD	420.00	489.00	490.00	509.00	420.00	489.00	490.00	509.00
Composite Primed Flat 1-1/16" x 3-1/2"	ADD	155.00	191.00	191.00	191.00	155.00	191.00	191.00	191.00
Composite White Cap Flat Casing 1-1/16" x 3-1/2"	ADD	168.00	207.00	207.00	207.00	168.00	207.00	207.00	207.00
PVC Brickmould	ADD	82.00	83.00	134.00	134.00	82.00	83.00	134.00	134.00
PVC Brickmould w/J-Channel	ADD	159.00	172.00	231.00	230.00	159.00	172.00	231.00	230.00
PVC Flat	ADD	219.00	242.00	242.00	246.00	219.00	242.00	242.00	246.00
PVC Flat w/J-Channel	ADD	289.00	315.00	315.00	321.00	289.00	315.00	315.00	321.00

NOTE: Items priced in *italics* are factory order – please allow additional lead time.

Weatherstripping - (components only not applied)

Piece Compression Weatherstrip Bronze or White 81"	\$ 4.20 each	Corner Seal Pad	\$0.80 each
Piece Compression Weatherstrip Bronze or White 85"	4.20 each	2-6 Door Bottom Bronze	7.00 each
Piece Compression Weatherstrip Bronze or White 97"	5.40 each	2-8 Door Bottom Bronze	8.20 each
Piece Magnetic Weatherstrip Tan 81"	14.80 each	3-0 Door Bottom Bronze	9.00 each
Piece Magnetic Weatherstrip Tan 97"	18.30 each	3-6 Door Bottom Bronze	10.10 each

STANDARD FRAME

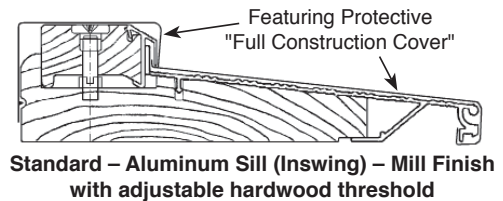
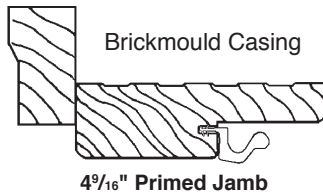

JAMB & SILL OPTIONS

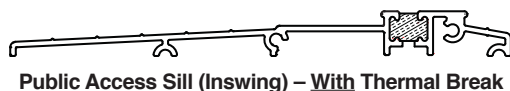
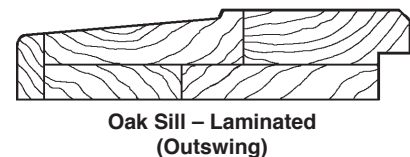
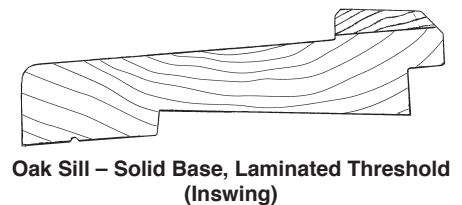
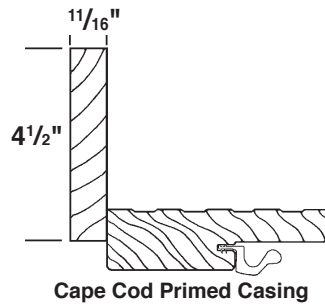
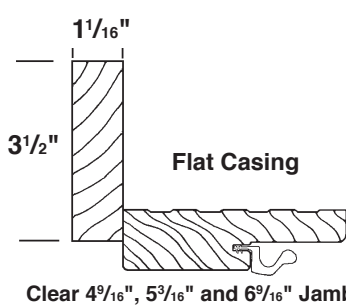
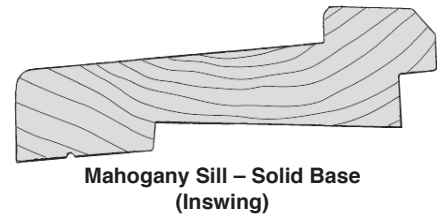
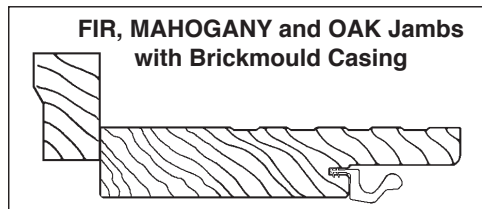
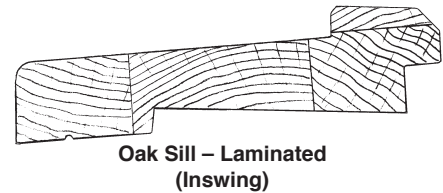
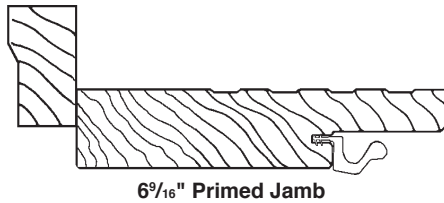
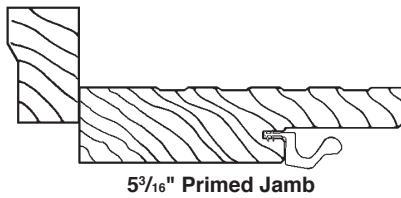

Optional Sill Pan available for Single, Double and Sidelight Units - 4-9/16" and 6-9/16" wall thickness.



Rough Opening & Unit Dimensions



Adjustments to 6'-8" Height:

6'-6" Height Units – Deduct 2"

7'-0" Height Units – Add 4"

8'-0" Height Units – Add 16"

INSWING DOOR SYSTEM - STANDARD ALUMINUM SILL

- Oak & Mahogany Sill - ADD 1/2" to Height of all dimensions
- Public Access Aluminum Sill - Deduct 1" from Height of all dimensions

Size	Rough Opening	Unit Dimension No Casing	Unit Dimension w/ Brickmould	Unit Dimension w/ 1-1/16" x3-1/2" Flat Casing
2-6 x 6-8	32 1/2 x 82 1/2	31 3/8 x 81 3/4	34 x 83	37 x 84 1/2
2-8 x 6-8	34 1/2 x 82 1/2	33 3/8 x 81 3/4	36 x 83	39 x 84 1/2
3-0 x 6-8	38 1/2 x 82 1/2	37 3/8 x 81 3/4	40 x 83	43 x 84 1/2
5-0 x 6-8	63 x 82 1/2	61 7/8 x 81 3/4	64 1/2 x 83	67 1/2 x 84 1/2
5-4 x 6-8	67 x 82 1/2	65 7/8 x 81 3/4	68 1/2 x 83	71 1/2 x 84 1/2
6-0 x 6-8	75 x 82 1/2	73 7/8 x 81 3/4	76 1/2 x 83	79 1/2 x 84 1/2

For 8'-0" Height Units – add 16" to all height dimensions shown.

OUTSWING DOOR SYSTEM - STANDARD ALUMINUM SILL OR PUBLIC ACCESS SILL

- Oak & Mahogany Sill - ADD 3/4" to Height of all dimensions
- Public Access Aluminum Sill - Use Table AS IS

Size	Rough Opening	Unit Dimension No Casing	Unit Dimension w/ Brickmould	Unit Dimension w/ 1-1/16" x3-1/2" Flat Casing
2-6 x 6-8	32 1/2 x 81 1/2	31 3/8 x 80 7/8	34 1/2 x 82 3/8	37 1/2 x 83 7/8
2-8 x 6-8	34 1/2 x 81 1/2	33 3/8 x 80 7/8	36 1/2 x 82 3/8	39 1/2 x 83 7/8
3-0 x 6-8	38 1/2 x 81 1/2	37 3/8 x 80 7/8	40 1/2 x 82 3/8	43 1/2 x 83 7/8
5-0 x 6-8	63 x 81 1/2	61 7/8 x 80 7/8	65 x 82 3/8	68 x 83 7/8
5-4 x 6-8	67 x 81 1/2	65 7/8 x 80 7/8	69 x 82 3/8	72 x 83 7/8
6-0 x 6-8	75 x 81 1/2	73 7/8 x 80 7/8	77 x 82 3/8	80 x 83 7/8

For 8'-0" Height Units – add 16" to all height dimensions shown.

DOOR & SIDELIGHT UNIT INSWING DOOR SYSTEM - STANDARD ALUMINUM SILL

Mull Post or Jamb to Jamb - Same Width Dimensions

- Oak & Mahogany Sill - ADD 1/2" to Height of all dimensions
- Public Access Aluminum Sill - Deduct 1" from Height of all dimensions

Size		Rough Opening	Unit Dimension No Casing	Unit Dimension w/ Brickmould	Unit Dimension w/ 1-1/16"x3-1/2" Flat Casing
3-0 x 6-8	w/ (1) 10" Sdlr	50 x 82 1/2	48 7/8 x 81 3/4	51 1/2 x 83	54 1/2 x 84 1/2
3-0 x 6-8	w/ (1) 12" Sdlr	52 x 82 1/2	50 7/8 x 81 3/4	53 1/2 x 83	56 1/2 x 84 1/2
3-0 x 6-8	w/ (1) 14" Sdlr	54 x 82 1/2	52 7/8 x 81 3/4	55 1/2 x 83	58 1/2 x 84 1/2
3-0 x 6-8	w/ (2) 10" Sdlrs	61 1/2 x 82 1/2	60 3/8 x 81 3/4	63 1/2 x 83	66 1/2 x 84 1/2
3-0 x 6-8	w/ (2) 12" Sdlrs	65 1/2 x 82 1/2	64 3/8 x 81 3/4	67 x 83	70 x 84 1/2
3-0 x 6-8	w/ (2) 14" Sdlrs	69 1/2 x 82 1/2	68 3/8 x 81 3/4	71 x 83	74 x 84 1/2

For Transom Unit Height add the Transom frame height to the appropriate dimension to obtain new height.

***Exterior Doors are beautiful...
when installed properly and
finished correctly!***

**Exterior Doors have
to be protected with proper
overhangs and finishing.**

**Manufacturers require this in order
to provide valid warranty coverage.**

The protection of your door is a major factor in its maintenance requirements and longevity. To adequately protect your door and extend its life, several factors must be considered. All the following have an affect on the durability of a door: door type, climate, exposure, color choice, overhang and the use of a storm door with sufficient ventilation.

For best performance and to meet the manufacturer's warranty, any exterior door should be installed under an overhang. Adequate overhang depends on typical weather conditions of the area where the door is installed, but at the minimum means an overhang projecting a distance from the structure equal to one half the distance between the bottom of the door and the bottom of the overhang.

Warranties may vary by manufacturer. Please visit our website for specific details – www.brosco.com.

Climate	Direction Door Faces			
	North	South	East	West
Mild	$X = 1/2 Y$	$X = Y$	$X = 1/2 Y$	$X = Y$
Wet	$X = Y$	$X = Y$	$X = Y$	$X = Y$
Ocean	$X = 1/2 Y$	$X = Y$	$X = 1/2 Y$	$X = Y$

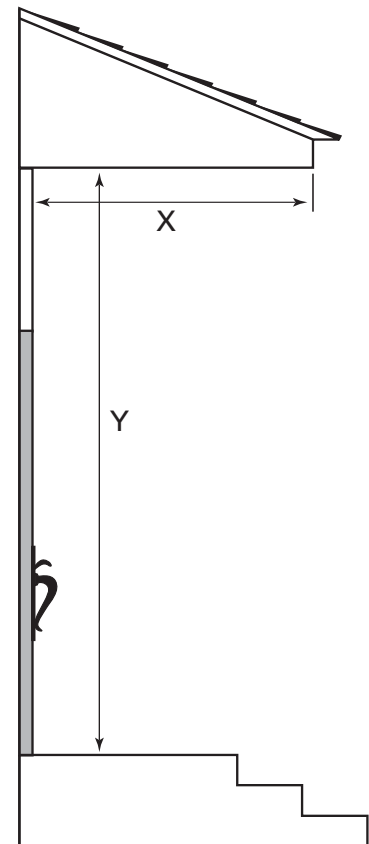

Where X is the length of the overhang required and Y is the distance from the bottom of the door to the base of the overhang.



NOTES



Date:
Copy:

Subject:	Page No.

COMMENTS

Notes

- 1.
- 2.
- 3.
- 4.
- 5.
- 6.
- 7.
- 8.
- 9.
- 10.
- 11.
- 12.
- 13.
- 14.
- 15.
- 16.
- 17.
- 18.
- 19.
- 20.
- 21.
- 22.
- 23.
- 24.
- 25.
- 26.
- 27.
- 28.
- 29.
- 30.
- 31.
- 32.