

TABLE OF CONTENTS

INTEX Milled PVC Mouldings..... CM-2

Extruded PVC Mouldings CM-2

INTEX PVC Pergolas System CM-3

INTEX PVC Gutter System..... CM-4

INTEX PVC Window Surrounds CM-5

HAAS Architectural Millwork (Urethane Product) CM-6 and 7



Custom Capabilities: Shop Services - Product Offering



With state of the art manufacturing equipment, INTEX has the ability to precisely cut and mill PVC component parts to exact specification. Dependant upon the design, these components may further be assembled to provide either "sub-assemblies or finished goods". Many standard products can be modified for custom look with minimal cost impact.



Dartmouth Rail with custom Newel and Mahogany cap



Radius Door Trim



Outdoor Shower

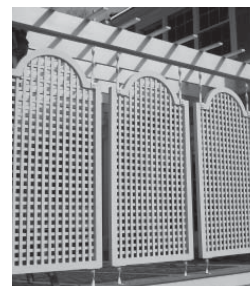

Lattice Panels



Pergolas

Online Quote Tools:

The INTEX web-site features their Quick-Quote tool to quote:

***Pergola Systems • Window & Door Surrounds • Newel Posts • Column Wraps
Mouldings • Railing Systems • Entry Systems***

Each Quick-Quote configurator allows users to "build" customized product based on application requirements and personal taste. A BROSCO List Price is generated.







<http://www.intexmillwork.com/quick-quote>



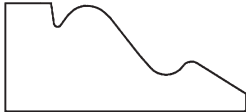
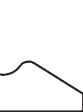

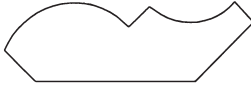

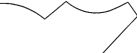

INTEX Milled & Primed PVC Moulding

INTEX Mouldings are milled to standard industry patterns, profile sanded and primed. Ready for installation. Shipped in 17'-6" lengths.

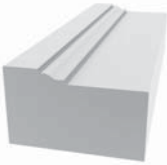
BAND		BASE MOULDING		BED		
						
PVC 8463 IBB005 5/8" x 1 1/2" \$75.39	PVC 8465 IBB004 5/8" x 1 3/4" \$55.08	PVC 8455 (PVC WM163) IBA006 1 1/16" x 1 3/8" \$65.33		PVC 8016 (PVC WM74) IBD005 9/16" x 1 3/4" x 18' \$69.77	PVC 8018 (PVC WM72) IBD006 9/16" x 2 1/4" \$80.44	PVC 8019 (PVC WM70) IBD004 9/16" x 2 3/4" \$91.77
CROWN						
						
PVC 8003 ICM013 9/16" x 2 3/4" \$87.08	PVC 8004 ICM014 1 1/16" x 5 1/4" \$145.86	PVC 8009 (PVC WM49) ICM012 1 1/16" x 3 5/8" \$110.63	PVC 8010 (PVC WM52) ICM016 9/16" x 2 3/4" \$87.08			

Extruded PVC Mouldings

BAND		BRICKMOULD		CASING	
	7901 (8465) 5/8" x 1 3/4" 16'-0" \$23.00		7137 (908) 1 1/4" x 2" 17'-0" \$35.00		
				7351 (908) Brickmould w/J-Channel 1 1/4" x 3" 7'-0" \$24.00 17'-0" 57.00	7467 Flat Casing w/J-Channel 1 1/8" x 3 1/2" 8'-0" \$56.00 18'-0" 125.00
DOOR & WINDOW					
	7631 Window Sill 2" x 1 3/4" 16'-0" \$109.00		7640 Historic Sill 2 1/4" x 2 3/4" 16'-0" \$162.00		

PVC Column Wraps are now located in the Column Wraps & Posts Section.



INTEX Millwork Solutions Pergola Systems are as strong as they are beautiful, and designed for a secure, easy pergola installation. Our cellular PVC pergola components are sleeved over structural aluminum internal reinforcements to provide strength and durability.

- ◆ Aluminum reinforced cellular PVC components
- ◆ Complete bracket system for easy installation
- ◆ Low-Maintenance
- ◆ Cellular PVC components will not rot, warp, crack or peel
- ◆ Aluminum reinforcements and brackets will not rust or corrode
- ◆ Quality stainless steel screws and fasteners will not rust or bleed onto the structure
- ◆ Pergola Systems engineered to meet International Building Code available
- ◆ Multiple standard pergola tail designs to choose from

Visit intexmillwork.com – web-based pergola configurator to customize and price your next project.

Classic Kit –

The Classic Kit is an economical pergola system designed for small backyard projects. The Classic Kit provides a solution for your freestanding or attached to structure pergola project.

Classic Kit Support Specifications

Rafter Size	Max. Span
2" x 5-1/2"	14'

Beam Size	Max. Span	Max. Rafter Span
2" x 8-3/4"	14'	14'

Classic Kit Standard Tail Designs

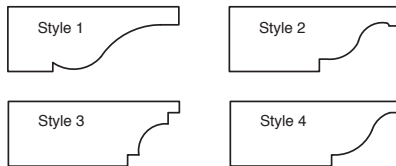

Deluxe Kit –

The Deluxe is a high quality pergola system with customizable options. Available as a freestanding or attached to structure pergola application, the Deluxe is the perfect finishing touch for your outdoor living space.

Deluxe Kit Support Specifications

Rafter Size	Max. Span
2-1/2" x 7-3/16"	14'

Beam Size	Max. Span	Max. Rafter Span
2-1/2" x 9-3/16"	14'	14'

Deluxe Kit Standard Tail Designs

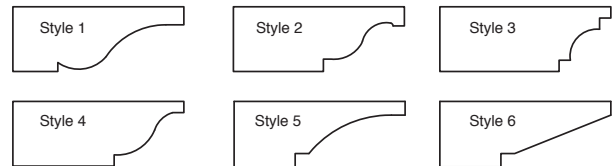

Premium Kit –

The Premium pergola system allows you to customize your pergola to meet your project specifications. The heavy-duty design of the Premium pergola system is engineered to meet International Building Code for commercial and residential applications.

Premium Kit Support Specifications

Rafter Size	Max. Span	Ice Load
2-1/2" x 7-3/16"	16'	1" Ice Load
2-1/2" x 7-3/16"	18'	3/4" Ice Load
2-1/2" x 9-3/16"	22'	1" Ice Load
2-1/2" x 9-3/16"	25'	1/2" Ice Load

Beam Size	Max. Span	Max. Rafter Span	Ice Load
3-1/4" x 11-15/16"	14'	25'	1" Ice Load
3-1/4" x 11-15/16"	16'	16'	1" Ice Load
5" x 11-15/16"	18'	25'	1" Ice Load
5" x 11-15/16"	20'	23'	1" Ice Load
7-1/2" x 12-1/8"	23'	25'	1" Ice Load
7-3/4" x 12-3/8"	25'	25'	1" Ice Load

Premium Kit Standard Tail Designs

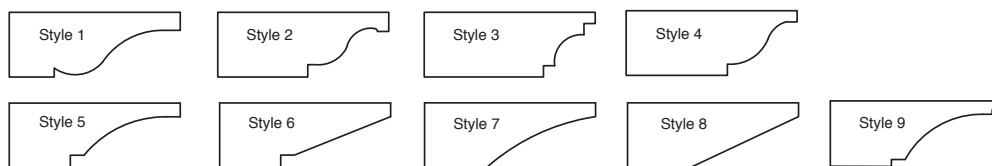

Boston Gutter System

Better than wood and historically accurate gutter system.



The PVC Boston Gutter System offers the full aesthetic appeal of wood with strength and durability, but it weighs less and has more carrying capacity of a standard wood gutter. PVC is easy to install, with no special tools required. With no painting, no oiling, no worrying, the Boston Gutter System is a low-maintenance system.

- ◆ Extruded Cellular PVC
- ◆ Full Aesthetic Appeal of Wood
- ◆ Tested and Engineered by Independent Lab
- ◆ Available in 10' and 20' Lengths
- ◆ 90° Splice Kits For Inside and Outside Corners and 180° Splice Kits
- ◆ End Cap Kits
- ◆ Downspout Outlet Kits
- ◆ Bracket System to Hang & Float Gutter
- ◆ All Seams Utilize 3M VHB Seals
- ◆ Can be Painted (LRV Greater Than 55)
- ◆ Actual Gutter Dimension 5-3/8" x 3-1/2"

The Boston Gutter System was designed as a "System". All the components required to properly install the Boston Gutter System are available as accessory kits.



Straight Gutter
Hanger Bracket Kit 10'-0"
GBKTSET
\$69.58

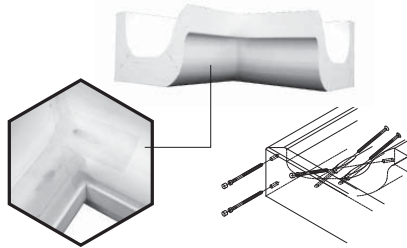
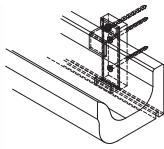

Inside Corner Splice Kit
GCORNER-IS
\$72.70

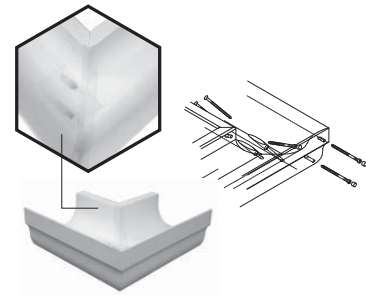

Outside Corner Splice Kit
GCORNER-OS
\$75.52

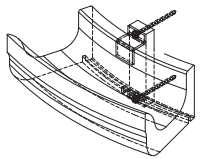

Radius Gutter
Hanger Bracket Kit 18'-0"
GBKTSET-R
\$124.54

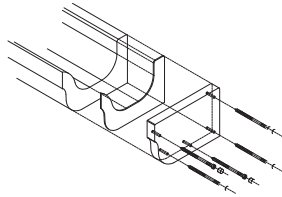

End Cap Kit
GENDCAP
\$46.14

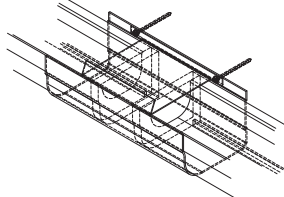

Expansion Joint Kit
GEXPJOINT
\$146.47

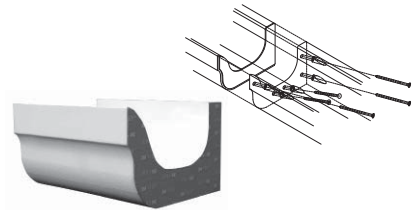

180° Splice Kit
GSPLICE
\$29.52

Gutter Sections		
4" x 6" x 10'-0" Straight Gutter	G46-10	\$ 284.66
4" x 6" x 20'-0" Straight Gutter	G46-20	569.32
4" x 6" x 18'-0" Radius Gutter	G46-R18	<i>1306.50</i>
Moulding		
Scotia Moulding 18'-0" Straight	GSCOTIA	\$183.66
Scotia Moulding 18'-0" Radius	GSCOTIA-R	<i>279.00</i>
Tools		
Drill Jig - Reusable	GJIG	\$241.41
Driver Bit Cortex for End & Corner Kits	GCBIT	10.59

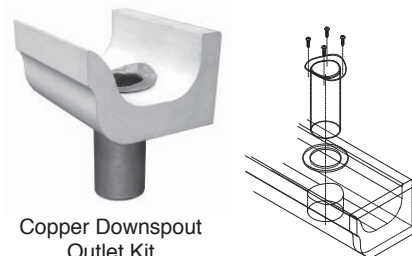

Copper Downspout
Outlet Kit
GC2OUTLET
\$63.61

Items priced in *italics* are factory order – please allow additional lead time.



INTEX Window Surrounds are manufactured from 100% cellular PVC board stock, and are milled for a precise fit around any window size and style. In addition to the multitude of "standard" shapes and profiles available, custom surrounds designed to your unique specifications, whether for new construction or restoration, are always readily manufactured for your job. Surrounds can be ordered fully assembled or as a kit for assembly on site. All INTEX surrounds are securely packaged and shrink wrapped to arrive clean and free from damage.

Window Surrounds

All INTEX Window Surrounds are manufactured to your design specifications. To fit a new window unit installation or to retro-fit an existing window.



Pediment Mouldings

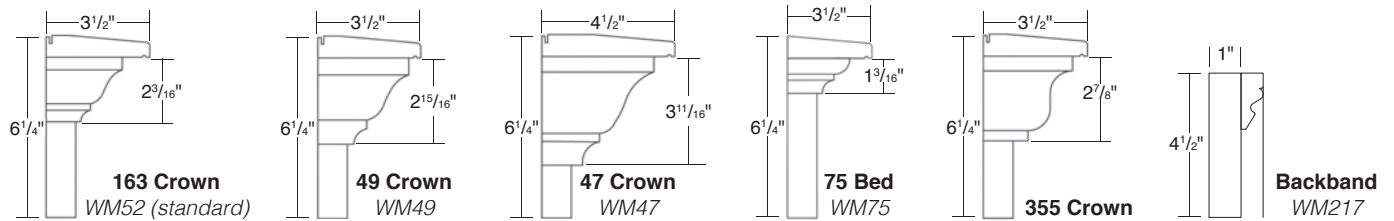

Head & Side Casing Profiles

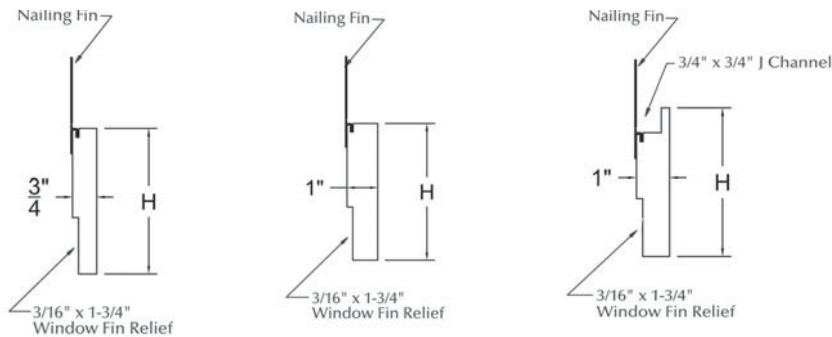

For pricing please use the INTEX online quote tool:

www.intexmillwork.com/quick-quote
A BROSCO List Price will be generated.

Sill Options

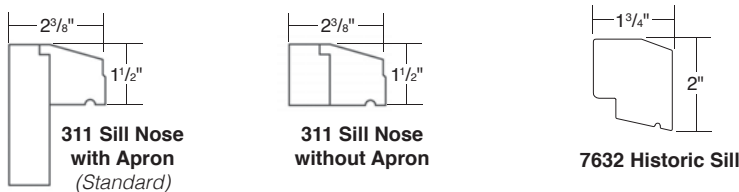

All window surrounds are factory orders – Please allow additional lead time.

HAAS Architectural Millwork is committed to manufacturing the highest quality urethane millwork solutions for the building industry. If you can dream it and design it, HAAS can make it.

IN STOCK Haas Architectural Millwork:

- Moulding
- Balustrades
- Railings
- Entrance Trim
- Gable Decorations
- Louvers
- Pediment Heads
- Ceiling Medallions
- Rosettes
- Brackets

The edges of Haas Architectural Millwork products have a sharp, clean look and offer the true authentic look of wood, but will not rot. All products come factory primed and will hold paint better than wood. They can be finished with any high quality exterior latex paint. The water based product line is environmentally friendly.



Including the collection of in stock material, the Haas Master Patternmakers are able to create custom pieces of millwork for your next project. For Special Order custom millwork designs or sizes, please contact the BROSCO Special Order Department for pricing.

Brackets

BRACKETS	MODEL #	List Price
4-7/8" X 8" X 8"	HBKT 100	\$ 30.00
7-5/8" X 18-1/4" X 6-5/8"	HBKT 108-1	100.00
1-1/4" X 12" X 12"	HBKT 403-12	41.00
3" X 10-5/8" X 7-1/2"	HBKT 406-10	40.00
4-1/2" X 16" X 10-1/2"	HBKT 408-16	83.00
3-1/2" X 10" X 5-1/4"	HBKT 409-10	28.00
1" X 11-7/8" WAGON WHEEL	HBKT 411-12	27.00
6" X 36" X 36"	HBKT 418-36	398.00
4" X 23-7/8" X 18-5/8"	HBKT 426-24	121.00
8-1/4" X 3-3/4" X 8"	HBKT 488	31.00
2" X 15-7/8" X 15-7/8"	HBKT 1616	61.00
5" X 10" X 17"	HBKT 1710	118.00
7-1/4" X 10" X 18"	HBKT 1810	82.00
5-7/8" X 40" X 34"	HBKT 63440	218.00

Dentil Blocks

DENTIL BLOCKS		
4-3/8" X 4-1/2" X 20-1/4"	HDB 122	\$43.00
5-1/8" X 3-1/2" X 7-3/4"	HDB 470-1	18.00
4-1/4" X 5" X 7-3/4"	HDB 470-2	19.00
5-3/4" X 5-7/8" X 9-3/4"	HDB 477-1	30.00
6" X 4-3/4" X 5"	HDB 510	16.00
4-1/2" X 3-3/4" X 8-5/8"	HDB 800	22.00
LH 4.5" X 3-3/4" X 8-5/8"	HDB 800-LP8-1	30.00
RH 4.5" X 3-3/4" X 8-5/8"	HDB 800-RP8-1	30.00

Made in the USA



Window Features

WINDOW HEAD	MODEL #	List Price
6" X 3" X 30"	HWH 900-30	\$ 60.00
6" X 3" X 32"	HWH 900-32	60.00
6" X 3" X 33-5/8"	HWH 900-33-5/8	62.00
6" X 3" X 36"	HWH 900-36	62.00
6" X 3" X 37-5/8"	HWH 900-37-5/8	62.00
6" X 3" X 41-5/8"	HWH 900-41-5/8	64.00
6" X 3" X 47"	HWH 900-47	72.00
6" X 3" X 48"	HWH 900-48	74.00
6" X 3" X 56"	HWH 900-56	86.00
6" X 3" X 72"	HWH 900-72	104.00
6" X 3" X 76"	HWH 900-76	114.00
6" X 3" X 80"	HWH 900-80	119.00
9" X 3" X 41-5/8"	HWH 901-41-5/8	83.00
9" X 4" X 32"	HWH 902-32	69.00
9" X 4" X 37-5/8"	HWH 902-37-5/8	80.00
9" X 4" X 40"	HWH 902-40	84.00
9" X 4" X 52"	HWH 902-52	109.00
9" X 4" X 96"	HWH 902-96	200.00
10" X 4" X 36" w/Bottom Trim	HWH 903-36	98.00
10" X 4" X 54" w/Bottom Trim	HWH 903-54	138.00

WINDOW HEAD w/KEYSTONE	MODEL #	List Price
6" X 3" X 36" w/Keystone	HWHK 900-36	\$ 88.00
6" X 3" X 37-5/8" w/Keystone	HWHK 900-37-5/8	88.00
6" X 3" X 40" w/Keystone	HWHK 900-40	88.00
6" X 3" X 41-5/8" w/Keystone	HWHK 900-41-5/8	89.00
6" X 3" X 42" w/Keystone	HWHK 900-42	89.00
6" X 3" X 60" w/Keystone	HWHK 900-60	117.00
6" X 3" X 74" w/Keystone	HWHK 900-74	131.00
6" X 3" X 76" w/Keystone	HWHK 900-76	133.00
9" X 4" X 33-5/8" w/Keystone	HWHK 902-33-5/8	115.00

LOUVERS	MODEL #	List Price
Round - Open 18"	HRL 18-O	\$ 75.00
Round - Open 22"	HRL 22-O	88.00
Round - Closed 24"	HRL 24-C	81.00
Round - Open 24"	HRL 24-O	94.00
Round - Closed 36"	HRL 36-C	139.00
Round - Open 36"	HRL 36-O	152.00
Round Keystone - Closed 24"	HRKL24-C	138.00
Round Keystone - Open 24"	HRKL24-O	154.00
Round Keystone - Closed 30"	HRKL30-C	147.00
Round Keystone - Open 30"	HRKL30-O	172.00
Half Round - Open 32"	HHRL 32-O	102.00
Half Round - Closed 36"	HHRL 36-C	95.00
Half Round - Open 36"	HHRL 36-O	108.00
Eyebrow Open 18" X 30"	HETL18X30-O	109.00
Triangle Open 36" X 18"	HTL 36x18-O	143.00
Triangle Closed 64" X 26"	HTL 64x26-C	173.00
Triangle Open 64" X 26"	HTL 64x26-O	187.00
Octagon Louver Closed 22"	HOCL 22-C	68.00
Octagon Louver Open 22"	HOCL 22-O	82.00
Rectangular Open 12" X 18"	HRECTL 12X18-O	70.00
Rectangular Open 12" X 24"	HRECTL 12X24-O	83.00
Rectangular Closed 16" X 24"	HRECTL 16X24-C	76.00
Rectangular Open 16" X 24"	HRECTL 16X24-O	91.00
Rectangular Closed 18" X 30"	HRECTL 18X30-C	88.00
Rectangular Open 18" X 30"	HRECTL 18X30-O	101.00
Rectangular Closed 24" X 36"	HRECTL 24X36-C	117.00
Rectangular Open 24" X 36"	HRECTL 24X36-O	132.00

WINDOW HEAD - HALF ROUND SUNBURST	MODEL #	List Price
32" Half Round Sunburst	HWH 911-32	\$ 95.00
37-5/8" Half Round Sunburst	HWH 911-37-5/8	107.00
60" Half Round Sunburst	HWH 911-60	216.00
76" Half Round Sunburst	HWH 911-76	328.00

WINDOW PANEL	MODEL #	List Price
18" X 36" W/4" Trim	HWP 300-18X36	\$85.00
21" X 36" W/4" Trim	HWP 300-21X36	97.00

FLAT HALF ROUND	MODEL #	List Price
1" X 3-1/2" X 29-5/8"	HARC 1104-29-5/8	\$78.00
1" X 3-1/2" X 36"	HARC 1104-36	80.00
1" X 3-1/2" X 48"	HARC 1104-48	92.00

MOULDING	MODEL #	List Price
Fascia 12-3/8" X 1-1/2" X 16'-0"	HMLD 379-16	\$245.00
Dormer Ret 4-1/4" X 4" X 10'-0"	HMLD 902-5-10	151.00
Ogee 1-7/8" X 1-3/8" X 16'-0"	HMLD 1001-16	54.00
Crown 3-7/8" X 3-7/8" X 16'-0"	HMLD 1002-16	121.00
Crown 2-3/4" X 2-3/4" X 16'-0"	HMLD 1006-16	93.00
Crown Fascia 7-3/4" X 5-3/4" X 16'-0"	HMLD 1009-16	210.00
Fascia 7-1/2" X 3-1/2" X 16'-0"	HMLD 1020-16	222.00
Crown Fascia 4" X 3-1/2" X 16'-0"	HMLD 1021-16	124.00
Crown 6-1/2" X 4-1/2" X 16'-0"	HMLD 1038-16	161.00
Win/Dr Csg 3-1/2" X 1-1/8" X 16'-0"	HMLD 1044-16	103.00
Casing 5-1/4" X 1" X 16'-0"	HMLD 1045-16	112.00
Dentil 4-1/2" X 1-1/8" X 16'-0"	HMLD 1049-16	74.00
Crown Dentil 6-1/2" X 3-1/2" X 16'-0"	HMLD 1051-16	128.00
Crown Dentil 5-1/4" X 4" X 16'-0"	HMLD 1054-16	143.00
Crown Dentil 4" X 3-1/8" X 16'-0"	HMLD 1061-16	113.00
Crown Dentil 3-3/8" X 2-5/8" X 16'-0"	HMLD 1062-16	95.00
Crown Fascia 9-1/8" X 3-3/8" X 16'-0"	HMLD 1066-16	313.00
Dentil 1-3/8" X 11/16" X 8'-0"	HMLD 1067-8	28.00
Dentil 6-1/4" X 3-3/4" X 16'-0"	HMLD 1069-16	267.00
Dentil 9-1/2" X 1-1/2" X 16'-0"	HMLD 1071-9-16	155.00
Chair Rail 2-3/8" X 1-1/2" X 16'-0"	HMLD 1073-16	66.00
Dentil 2-3/8" X 2-1/4" X 8'-0"	HMLD 1076-8	57.00
Dentil 3-3/8" X 1-3/8" X 8'-0"	HMLD 1079-8	46.00
Dentil 7-1/2" X 6" X 8'-0"	HMLD 1081-8	231.00
Panel 1-3/8" X 9/16" X 8'-0"	HMLD 1082-8	32.00
Cove 4-3/4" X 4-3/4" X 16'-0"	HMLD 2435-16	203.00
Crown Fascia Dentil 11-1/4" X 6-3/8" X 16'-0"	HMLD 3100-16	367.00

MISCELLANEOUS	MODEL #	List Price
Ball 5" Base 6-1/2" Height	HBALL 600-5	\$ 45.00
Ball 6" Base 8" Height	HBALL 600-6	60.00
Ball 7" Base 8-3/4" Height	HBALL 600-7	70.00
Ball 8-3/8" Base 12-7/8" Height	HBALL 600-10	131.00
Ceiling Medallion Renaissance 1-3/4" X 24-1/2"	HCM 2024-25	56.00
Ceiling Medallion Feather 2-3/4" X 27-3/4"	HCM 2025-28	62.00
Ceiling Medallion Leaf 1-1/8" X 23-7/8"	HCM 2026-24	114.00
Ceiling Medallion Plain 2-3/4" X 24"	HCM 5021-24	117.00
Ceiling Medallion Plain 2-3/4" X 31"	HCM 5021-31	125.00
Rosette 2" X 5-1/2" Bulls Eye	HROS 23	17.00
Rosette 1-3/16" X 3-3/4" Bulls Eye	HROS 71	13.00
Keystone Plain - Coped	HKST 900-C	21.00
Keystone Plain - Coped	HKST 902-C	38.00
Keystone Plain - Coped	HKST 1104-C	26.00



Notes



Date: _____
Name: _____

Subject: _____

COMMENTS

Notes

1. _____
2. _____
3. _____
4. _____
5. _____
6. _____
7. _____
8. _____
9. _____
10. _____
11. _____
12. _____
13. _____
14. _____
15. _____
16. _____
17. _____
18. _____
19. _____
20. _____
21. _____
22. _____
23. _____
24. _____
25. _____
26. _____
27. _____
28. _____
29. _____
30. _____
31. _____
32. _____