



BROSCO SSB Window Unit



Windows that Fit Northeast Lifestyles.

The Northeast's unique architectural styles and harsh climate demand windows that are quality built, energy efficient and fit the charm and character of the traditional home. From colonials and capes to a traditional saltbox home design, the BROSCO Window Unit offers classic styling that will satisfy the most discriminating tastes.



SINGLE THICK GLASS

Table of Contents

- Features of the BROSCO Double-Hung Single Thick Glazed Window Unit B-2
- Rough Openings / Unit Dimensions / Unit Detail..... B-3
- Size Grid & Pricing Guide: Equal Lights B-4 thru 9
- Size Grid & Pricing Guide: Cottage Style Units B-8 & 9
- Size Grid & Pricing Guide: Picture Units B-10
- Pricing Guide: Transom Units & Single Sash Stationary Units..... B-11 & 12
- Unit Options B-13
- Sash Details B-14
- Clear Pine Cellar Sash & Frames..... B-15
- Clear Pine Barn, Skylight & Single Sash B-16
- Primed Cellar, Barn & Single Sash..... B-17
- Care & Finishing B-18

SINGLE THICK GLASS

Standard Features of a BROSCO Window Unit -

Frame – Wood Frame (4⁹/₁₆" wall):

- Clear Head & Side Jambs.
- Treated with a moisture repellent preservative.
- Exterior surfaces are factory primed.
- **Composite Blind Stop & Brickmould Casing.**

Sill – Composite Sill & Nosing; impervious to rot and decay; resists termites and other insects.

Sash – Wood Sash: 1³/₈" Thick. Mortise and Tenon construction. Preservative treated; Primed exterior, Natural Clear Pine interior. **Putty Glazed.** Horizontal weatherstrip applied.

Glazing – Wood Sash: Authentic Putty Glazed

- 1³/₈" thick Sash with 1/1 Light Layout or Historically Correct Authentic Divided Lights
- Low-E Panel applied to 1³/₈" thick Sash with Historically Correct Authentic Divided Lights



BRICKMOULD CASING



FLAT CASING

Single Thick Glass SSB with Low-E Panel		
NFRC Rating		
	"U" Value	SHGC
1/1 Light	0.40	0.53
Authentic Divided Lights	0.42	0.48

Other Features –

- Vinyl Jamb Liners with Tilt 'n Clean Block & Tackle Counter-Balance (specify White or Beige).
- Weatherstripped Vinyl Head Parting Stop (Color Matched to Jamb Liner).
- Clear Pine Inside Stops (Side Jambs & Sill).
- Applied Cam-style Sash Lock (white), 2 per sash when glass size is 27" or wider.

Casing Options –

- **Composite Flat Casing**
 - 1¹/₁₆" x 3³/₄" Head and Sides
 - 1¹/₁₆" x 4¹/₂" Cape Cod Casing Head and Sides
- **Wood Flat Casing**
 - Treated & Primed: 1¹/₁₆" x 5¹/₄" Flat Casing
 - **Clear Cedar:** 1¹/₁₆" x 3³/₄" Flat Casing
Option for 1⁷/₁₆" x 3³/₄" Head Casing

Other Popular Options –

- Extension Jambs for 6⁹/₁₆" wall - applied.
- Insect Screens - Full, White Aluminum Frame with charcoal colored fiberglass mesh.
- Cam-style Sash Locks - Brasstone.
- Wood Grilles - shipped K.D. (polybagged with fasteners).
- Cedar Sill and Nosing/Connector.
- "Historic" Sill Nosing/Connector (Composite or Cedar).
- Long Sill Horns.
- Moulded Urethane Window Heads & Trims.

HOW-TO-ORDER A WINDOW UNIT	
1. Unit Description (glass size), Glazing Type	
2. Single, Mullion, Triple, etc. On mulled units, specify narrow mulls, single stud pocket mulls or special width stud pockets.	
3. Type and Size of Casing (Brickmould standard) For "No Casing" units 3 ³ / ₄ " Sill Horns will be used unless otherwise specified.	
4. Jamb Width (4 ⁹ / ₁₆ " standard) or with 6 ⁹ / ₁₆ " Extension Jambs.	
5. Optional extras (Full Screens, Wood Grilles, etc.).	

	Single Opening	Mullion (Narrow)	Mullion (w/Single Stud Pocket)	Triple ★ (Narrow)	Triple ★ (w/Single Stud Pocket)
<div style="writing-mode: vertical-rl; transform: rotate(180deg);"> Total glass + 9" Total glass + 8⁷/₈" Total glass + 9⁵/₈" Total glass + 11³/₈" Total glass + 12¹/₈" </div> <div style="writing-mode: vertical-rl; transform: rotate(180deg);"> Rough Opening Unit Dimension Brickmould Casing Flat Casing (3³/₄") Cape Cod Casing </div>	Total glass + 6"	Total glass + 10 ⁷ / ₈ "	Total glass + 12 ⁷ / ₈ "	Total glass + 15 ³ / ₄ "	Total glass + 19 ³ / ₄ "
	Total glass + 4 ⁷ / ₈ "	Total glass + 9 ³ / ₄ "	Total glass + 11 ³ / ₄ "	Total glass + 14 ⁵ / ₈ "	Total glass + 18 ⁵ / ₈ "
	Total glass + 7 ⁵ / ₈ "	Total glass + 12 ¹ / ₂ "	Total glass + 14 ¹ / ₂ "	Total glass + 17 ³ / ₈ "	Total glass + 21 ³ / ₈ "
	Total glass + 11"	Total glass + 15 ⁷ / ₈ "	Total glass + 17 ⁷ / ₈ "	Total glass + 20 ³ / ₄ "	Total glass + 24 ³ / ₄ "
	Total glass + 12 ³ / ₄ "	Total glass + 17 ⁵ / ₈ "	Total glass + 19 ⁵ / ₈ "	Total glass + 22 ¹ / ₂ "	Total glass + 26 ¹ / ₂ "

★ Picture with Flankers or 3 of a kind

Sash Opening Width: Total glass + 3⁵/₈" Sash Opening Height: Total glass + 5"

	Quad (Narrow)	Quad (w/Single Stud Pocket)	Quint (Narrow)	Quint (w/Single Stud Pocket)
<div style="writing-mode: vertical-rl; transform: rotate(180deg);"> Total glass + 9" Total glass + 8⁷/₈" Total glass + 9⁵/₈" Total glass + 11³/₈" Total glass + 12¹/₈" </div> <div style="writing-mode: vertical-rl; transform: rotate(180deg);"> Rough Opening Unit Dimension Brickmould Casing Flat Casing (3³/₄") Cape Cod Casing </div>	Total glass + 20 ⁵ / ₈ "	Total glass + 26 ⁵ / ₈ "	Total glass + 25 ⁵ / ₈ "	Total glass + 33 ⁵ / ₈ "
	Total glass + 19 ¹ / ₂ "	Total glass + 25 ¹ / ₂ "	Total glass + 24 ³ / ₈ "	Total glass + 32 ³ / ₈ "
	Total glass + 22 ¹ / ₄ "	Total glass + 28 ¹ / ₄ "	Total glass + 27 ¹ / ₈ "	Total glass + 35 ¹ / ₈ "
	Total glass + 25 ⁵ / ₈ "	Total glass + 31 ⁵ / ₈ "	Total glass + 30 ¹ / ₂ "	Total glass + 38 ¹ / ₂ "
	Total glass + 27 ³ / ₈ "	Total glass + 33 ³ / ₈ "	Total glass + 32 ¹ / ₄ "	Total glass + 40 ¹ / ₄ "

Standard Frame Details

- 4⁹/₁₆" Wall
- Composite Brickmould Casing
- Composite Standard Sill Nosing

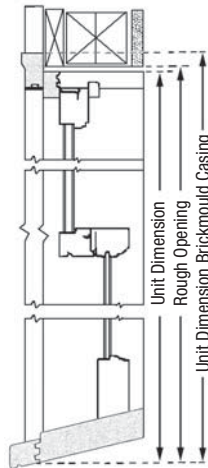
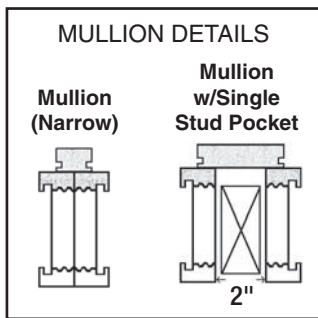

Optional Composite "Historic" Sill Nosing / Connector

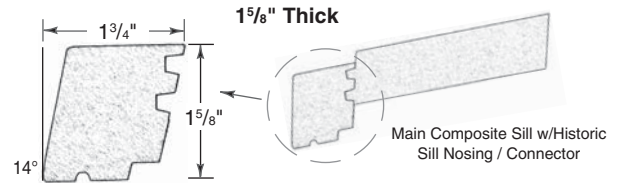

Standard Cedar Sill Nosing / Connector

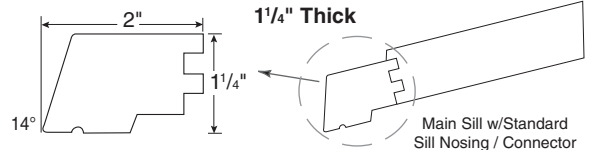

Optional "Historic" Cedar Sill Nosing / Connector

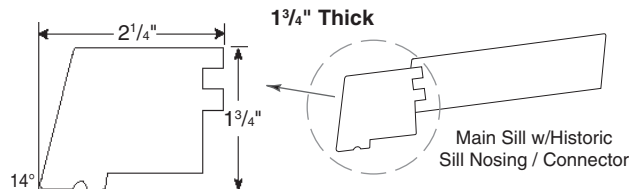

Standard Composite Sill Nosing / Connector

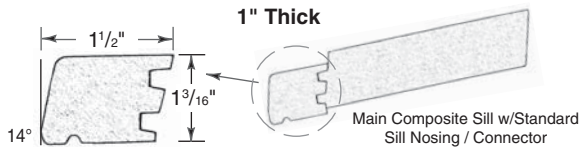

Shaded areas indicate composite.

Basic Unit Features:

- **Frame** – 4⁹/₁₆" Clear Side Jambs, Treated and Primed. **Composite Blind Stop.**
- **Sill** – **Composite Sill and Nosing.**
- **Casing** – **Composite Brickmould** standard.
- **Sash** – Wood Sash: 1³/₈" Thick, Putty Glazed with Single Thick Glass
Primed Exterior, Clear Pine Interior
or
Putty Glazed SSB Glass with Low "E" Energy Panel
- Tilt 'n Clean Block & Tackle Balance System with Vinyl Jamb Liners (specify beige or white)
- Weatherstripped Head Parting Stop
- Pine Inside Stops – Sides & Sill
- Cam Sash Lock applied (white)
2 per sash when glass size is 27" or wider

SINGLE THICK GLASS (SSB) 1/1 LIGHT

Rough Opening			1'-10"			2'-6"			2'-9"		
● Sash Opening			1'-7 ⁵ / ₈ "			2'-3 ⁵ / ₈ "			2'-6 ⁵ / ₈ "		
★ Glass Size			16"			24"			27"		
3'-5"	3'-1"	16"	1	16" x 16"	2	24" x 16"	—				
4'-1"	3'-9"	20"	—			3	24" x 20"	—			
4'-9"	4'-5"	24"	—			4	24" x 24"	5	27" x 24"		

Windows shown with optional wood grille patterns.

AUTHENTIC DIVIDED LIGHT (SSB or SSB w/Low "E" Panel)

6/6 LIGHT

Rough Opening			2'-0"		2'-3"		2'-6"		2'-9"		3'-0"		3'-6"	
● Sash Opening			1'-9 ⁵ / ₈ "		2'-0 ⁵ / ₈ "		2'-3 ⁵ / ₈ "		2'-6 ⁵ / ₈ "		2'-9 ⁵ / ₈ "		3'-3 ⁵ / ₈ "	
★ Glass Size			6"		7"		8"		9"		10"		12"	
3'-1"	2'-9"	7"	—		—		3	8" x 7"	10	9" x 7"	—		—	
3'-5"	3'-1"	8"	1	6" x 8"	—		4	8" x 8"	11	9" x 8"	19	10" x 8"	—	
3'-9"	3'-5"	9"	—		2	7" x 9"	5	8" x 9"	12	9" x 9"	20	10" x 9"	—	
4'-1"	3'-9"	10"	—		—		6	8" x 10"	13	9" x 10"	21	10" x 10"	—	
4'-5"	4'-1"	11"	—		—		7	8" x 11"	14	9" x 11"	22	10" x 11"	—	
4'-9"	4'-5"	12"	—		—		8	8" x 12"	15	9" x 12"	23	10" x 12"	—	
5'-1"	4'-9"	13"	—		—		9	8" x 13"	16	9" x 13"	24	10" x 13"	—	
5'-5"	5'-1"	14"	—		—		—		17	9" x 14"	25	10" x 14"	—	
5'-9"	5'-5"	15"	—		—		—		18	9" x 15"	26	10" x 15"	28	12" x 15"
6'-1"	5'-9"	16"	—		—		—		—		27	10" x 16"	—	

Maximize your window's performance by adding a LARSON® Storm Window – See LARSON Storm & Venting Products (Tab LAR)

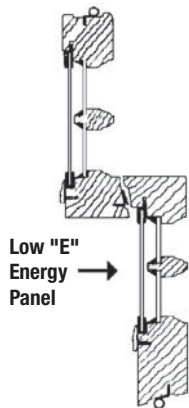

Low "E" Energy Panel Tilt 'n Clean Unit – BROSCO's Low "E" Energy Panel is available on most single thick glass (SSB) units to provide better energy efficiency.

● Actual sash width = sash opening width minus 1⁹/₁₆".
★ Glass sizes are approximate.

Illustrations not to scale.



BROSCO SSB Window Unit

PRICING



1/1 LIGHT		Wood Sash	Set-Up Unit Options					Replacement	
Unit Description (Glass Size)	Single Thick Glass SSB w/Brickmould		*ADD Full Screen (White Frame)	ADD 6 ⁹ / ₁₆ " Ext. Jamb (Applied) ♠ ♣	*ADD Wood Grilles	ADD Composite Flat Casing 1 ¹ / ₁₆ " x 3 ³ / ₄ "	◇ DEDUCT No Casing	Sash Only SSB Glass	Tilt 'n Clean Block & Tackle Balances Only (White or Beige)
1	16" x 16"	<i>\$311.00</i>	\$16.00	\$36.00	\$25.00	\$25.00	-\$34.00	\$123.00	\$49.00
2	24" x 16"	332.00	18.00	36.00	34.00	25.00	-34.00	134.00	49.00
3	24" x 20"	360.00	20.00	36.00	34.00	33.00	-38.00	149.00	53.00
4	24" x 24"	<i>396.00</i>	22.00	36.00	34.00 ‡	34.00	-40.00	<i>174.00</i>	60.00
5	27" x 24"	409.00	22.00	36.00	34.00	34.00	-40.00	172.00	60.00

‡ Optional 12/12 Lt. Grille **\$64.00**

AUTHENTIC DIVIDED LIGHT (SSB or SSB w/Low "E" Panel)

6/6 LIGHT		Wood Sash		Set-Up Unit Options				Replacement		
Unit Description (Glass Size)	Single Thick Glass SSB w/Brickmould	Single Thick Glass SSB w/Low-E Panel w/Brickmould		*ADD Full Screen (White Frame)	ADD 6 ⁹ / ₁₆ " Ext. Jamb (Applied) ♠ ♣	ADD Composite Flat Casing 1 ¹ / ₁₆ " x 3 ³ / ₄ "	◇ DEDUCT No Casing	Sash Only SSB Glass	Sash Only SSB w/Low-E Energy Panel	Tilt 'n Clean Block & Tackle Balances Only (White or Beige)
1	6" x 8"	<i>\$362.00</i>	<i>\$473.00</i>	\$16.00	\$36.00	\$25.00	-\$34.00	\$170.00	\$281.00	\$49.00
2	7" x 9"	385.00	508.00	18.00	36.00	29.00	-34.00	185.00	308.00	52.00
3	8" x 7"	368.00	483.00	17.00	36.00	25.00	-34.00	174.00	289.00	48.00
4	8" x 8"	381.00	502.00	18.00	36.00	25.00	-34.00	183.00	304.00	49.00
5	8" x 9"	393.00	522.00	19.00	36.00	29.00	-34.00	190.00	319.00	52.00
6	8" x 10"	408.00	547.00	20.00	36.00	33.00	-38.00	197.00	336.00	53.00
7	8" x 11"	421.00	566.00	20.00	36.00	33.00	-38.00	206.00	351.00	56.00
8	8" x 12"	436.00	588.00	22.00	36.00	34.00	-40.00	214.00	366.00	60.00
9	8" x 13"	450.00	610.00	22.00	36.00	35.00	-42.00	221.00	381.00	63.00
10	9" x 7"	390.00	<i>549.00</i>	18.00	36.00	25.00	-34.00	181.00	<i>340.00</i>	48.00
11	9" x 8"	401.00	<i>569.00</i>	19.00	36.00	25.00	-34.00	188.00	<i>356.00</i>	49.00
12	9" x 9"	413.00	<i>594.00</i>	20.00	36.00	29.00	-34.00	195.00	<i>376.00</i>	52.00
13	9" x 10"	430.00	576.00	21.00	36.00	33.00	-38.00	204.00	350.00	53.00
14	9" x 11"	442.00	595.00	22.00	36.00	33.00	-38.00	212.00	365.00	56.00
15	9" x 12"	456.00	618.00	22.00	36.00	34.00	-40.00	219.00	381.00	60.00
16	9" x 13"	472.00	642.00	23.00	36.00	35.00	-42.00	228.00	398.00	63.00
17	9" x 14"	487.00	<i>715.00</i>	24.00	36.00	53.00	-46.00	235.00	<i>463.00</i>	65.00
18	9" x 15"	<i>501.00</i>	<i>687.00</i>	25.00	36.00	55.00	-46.00	<i>242.00</i>	<i>428.00</i>	68.00
19	10" x 8"	410.00	<i>622.00</i>	20.00	36.00	25.00	-34.00	194.00	<i>406.00</i>	49.00
20	10" x 9"	422.00	<i>648.00</i>	32.00	36.00	29.00	-34.00	201.00	<i>427.00</i>	52.00
21	10" x 10"	439.00	<i>634.00</i>	21.00	36.00	33.00	-38.00	210.00	<i>405.00</i>	53.00
22	10" x 11"	450.00	606.00	22.00	36.00	33.00	-38.00	217.00	373.00	56.00
23	10" x 12"	464.00	630.00	23.00	36.00	34.00	-40.00	224.00	390.00	60.00
24	10" x 13"	480.00	652.00	25.00	36.00	35.00	-42.00	233.00	405.00	63.00
25	10" x 14"	496.00	675.00	25.00	36.00	53.00	-46.00	241.00	420.00	65.00
26	10" x 15"	512.00	<i>754.00</i>	25.00	36.00	55.00	-46.00	250.00	<i>492.00</i>	68.00
27	10" x 16"	<i>531.00</i>	<i>778.00</i>	<i>36.00</i>	36.00	55.00	-46.00	<i>264.00</i>	<i>511.00</i>	72.00
28	12" x 15"	<i>602.00</i>	<i>789.00</i>	<i>36.00</i>	36.00	55.00	-46.00	<i>333.00</i>	<i>520.00</i>	68.00

- Mullion Unit (Single Unit times 2 plus)..... ADD **\$ 15.00**
 - Triple Unit (Single Unit times 3 plus)..... ADD **28.00**
 - Quad Unit (Single Unit times 4 plus)..... ADD **40.00**
 - Quint Unit (Single Unit times 5 plus)..... ADD **45.00**
 - Add for *Single Stud Pocket* (per pocket)..... ADD **23.00**
 - * Add for *Special Stud Pocket* (per pocket)..... ADD **31.00**
 - Brasstone Sash Lock Applied - each..... ADD **17.00**
- Double-Hung "Open Frame" Pricing - please call BROSCO.

For Replacement Sash Kit**

ADD pair of Sash only **plus**
set Tilt 'n Clean Block & Tackle Balances **plus**
Sash Lock(s)
plus \$27.00

Shop Item – Allow additional time

Sash Locks (not applied)

White	\$4.70 each
Brasstone	\$21.90 each

Allow 2 sash locks for glass size 27" or wider

OPTIONAL CASING & OTHER OPTIONS - PAGE B-13

NOTES: * Not Applied. ** Head Parting Stop color matched to balances. * Mull casing not included.

- ◇ 3³/₄" Sill horns will be used unless otherwise specified.
- ♠ Extension Jamb for Stud Pocket Units surround the individual units (sides & top).
- ♣ Extension Jamb adder applies to single units only. For all other configurations, see options page B-13.

Units greater than 12'-0" width utilizing Composite or Cedar Flat Casing will have a butt joint.
Items priced in *Italics* are Factory Order – Please allow additional lead time.

AUTHENTIC DIVIDED LIGHT (SSB or SSB w/Low "E" Panel)

Basic Unit Features:

- **Frame** – 4⁹/₁₆" Clear Side Jambs, Treated and Primed. **Composite Blind Stop.**
- **Sill** – **Composite Sill and Nosing.**
- **Casing** – **Composite Brickmould** standard.
- **Sash** – Wood Sash: 1³/₈" Thick, Putty Glazed with Single Thick Glass
Primed Exterior, Clear Pine Interior
or
Putty Glazed SSB Glass with Low "E" Energy Panel
- Tilt 'n Clean Block & Tackle Balance System with Vinyl Jamb Liners (specify beige or white)
- Weatherstripped Head Parting Stop
- Pine Inside Stops – Sides & Sill
- Cam Sash Lock applied (white)
2 per sash when glass size is 27" or wider

2/2 LIGHT – VERTICAL

Rough Opening			2'-3"	2'-6"	2'-9"	2'-10"	3'-0"	3'-2"
● Sash Opening			2'-0 ⁵ / ₈ "	2'-3 ⁵ / ₈ "	2'-6 ⁵ / ₈ "	2'-7 ⁵ / ₈ "	2'-9 ⁵ / ₈ "	2'-11 ⁵ / ₈ "
★ Glass Size			10 ¹ / ₂ "	12"	13 ¹ / ₂ "	14"	15"	16"
3'-9"	3'-5"	18"	1 10 ¹ / ₂ " x 18"	—	—	—	—	—
4'-1"	3'-9"	20"	—	3 12" x 20"	6 13 ¹ / ₂ " x 20"	—	—	—
4'-5"	4'-1"	22"	—	—	7 13 ¹ / ₂ " x 22"	—	—	—
4'-6"	4'-2"	22 ¹ / ₂ "	2 10 ¹ / ₂ " x 22 ¹ / ₂ "	—	—	—	—	—
4'-9"	4'-5"	24"	—	4 12" x 24"	8 13 ¹ / ₂ " x 24"	12 14" x 24"	16 15" x 24"	—
4'-11"	4'-7"	25"	—	5 12" x 25"	—	—	—	—
5'-1"	4'-9"	26"	—	—	9 13 ¹ / ₂ " x 26"	13 14" x 26"	17 15" x 26"	—
5'-5"	5'-1"	28"	—	—	10 13 ¹ / ₂ " x 28"	14 14" x 28"	18 15" x 28"	—
5'-9"	5'-5"	30"	—	—	11 13 ¹ / ₂ " x 30"	15 14" x 30"	19 15" x 30"	21 16" x 30"
6'-1"	5'-9"	32"	—	—	—	—	20 15" x 32"	22 16" x 32"

Maximize your window's performance by adding a LARSON® Storm Window – See LARSON Storm & Venting Products (Tab LAR)

2/2 LIGHT – HORIZONTAL

Rough Opening			2'-6"	2'-9"
● Sash Opening			2'-3 ⁵ / ₈ "	2'-6 ⁵ / ₈ "
★ Glass Size			24"	27"
3'-5"	3'-1"	8"	23 24" x 8"	25 27" x 8"
4'-1"	3'-9"	10"	24 24" x 10"	26 27" x 10"

2/1 LIGHT

Rough Opening			2'-6"	2'-9"	2'-10"	3'-0"
● Sash Opening			2'-3 ⁵ / ₈ "	2'-6 ⁵ / ₈ "	2'-7 ⁵ / ₈ "	2'-9 ⁵ / ₈ "
★ Glass Size			24"	27"	28"	30"
4'-9"	4'-5"	24"	27 24" x 24"	28 27" x 24"	—	—
5'-1"	4'-9"	26"	—	29 27" x 26"	—	—
5'-5"	5'-1"	28"	—	30 27" x 28"	31 28" x 28"	32 30" x 28"
5'-9"	5'-5"	30"	—	—	—	33 30" x 30"

3/3 LIGHT

Rough Opening		2'-9"
● Sash Opening		2'-6 ⁵ / ₈ "
★ Glass Size		9"
2'-9"	2'-5"	12"
—	—	34 9" x 12"

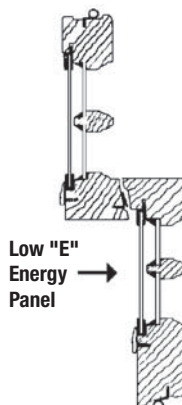

Low "E" Energy Panel Tilt 'n Clean Unit – BROSCO's Low "E" Energy Panel is available on most single thick glass (SSB) units to provide better energy efficiency.

Illustrations not to scale.

● Actual sash width = sash opening width minus 1⁹/₁₆".
★ Glass sizes are approximate.



BROSCO SSB Window Unit

PRICING



AUTHENTIC DIVIDED LIGHT (SSB or SSB w/Low "E" Panel)

Unit Description (Glass Size)	Wood Sash		Set-Up Unit Options				Replacement			
	Single Thick Glass SSB w/Brickmould	Single Thick Glass SSB w/Low-E Panel w/Brickmould	*ADD Full Screen (White Frame)	ADD 6 ⁹ / ₁₆ " Ext. Jamb (Applied) ♣	ADD Composite Flat Casing 1 ¹ / ₁₆ " x 3 ³ / ₄ "	◇ DEDUCT No Casing	Sash Only SSB Glass	Sash Only SSB w/Low-E Energy Panel	Tilt 'n Clean Block & Tackle Balances Only (White or Beige)	
2/2 LIGHT – VERTICAL										
1	10 ¹ / ₂ " x 18"	\$348.00	\$499.00	\$18.00	\$36.00	\$29.00	-\$34.00	\$148.00	\$299.00	\$52.00
2	10 ¹ / ₂ " x 22 ¹ / ₂ "	378.00	568.00	32.00	36.00	33.00	-39.00	165.00	355.00	56.00
3	12" x 20"	372.00	541.00	20.00	36.00	33.00	-38.00	161.00	330.00	53.00
4	12" x 24"	399.00	585.00	22.00	36.00	34.00	-40.00	177.00	363.00	60.00
5	12" x 25"	409.00	612.00	32.00	36.00	33.00	-42.00	181.00	384.00	61.00
6	13 ¹ / ₂ " x 20"	394.00	581.00	21.00	36.00	33.00	-38.00	168.00	355.00	53.00
7	13 ¹ / ₂ " x 22"	406.00	665.00	22.00	36.00	33.00	-38.00	176.00	435.00	56.00
8	13 ¹ / ₂ " x 24"	413.00	674.00	22.00	36.00	34.00	-40.00	176.00	437.00	60.00
9	13 ¹ / ₂ " x 26"	436.00	670.00	23.00	36.00	35.00	-42.00	192.00	426.00	63.00
10	13 ¹ / ₂ " x 28"	451.00	749.00	24.00	36.00	53.00	-46.00	199.00	497.00	65.00
11	13 ¹ / ₂ " x 30"	465.00	776.00	25.00	36.00	55.00	-46.00	206.00	517.00	68.00
12	14" x 24"	423.00	698.00	23.00	36.00	34.00	-40.00	185.00	460.00	60.00
13	14" x 26"	439.00	657.00	23.00	36.00	35.00	-42.00	194.00	412.00	63.00
14	14" x 28"	472.00	682.00	25.00	36.00	53.00	-46.00	219.00	429.00	65.00
15	14" x 30"	487.00	768.00	36.00	36.00	55.00	-46.00	227.00	508.00	68.00
16	15" x 24"	446.00	644.00	23.00	36.00	34.00	-40.00	206.00	404.00	60.00
17	15" x 26"	444.00	731.00	25.00	36.00	35.00	-42.00	197.00	484.00	63.00
18	15" x 28"	478.00	758.00	25.00	36.00	53.00	-46.00	223.00	503.00	65.00
19	15" x 30"	474.00	716.00	25.00	36.00	55.00	-46.00	212.00	454.00	68.00
20	15" x 32"	508.00	741.00	36.00	36.00	55.00	-46.00	241.00	474.00	72.00
21	16" x 30"	501.00	794.00	36.00	36.00	55.00	-46.00	237.00	530.00	68.00
22	16" x 32"	521.00	818.00	36.00	36.00	55.00	-46.00	252.00	549.00	72.00
2/2 LIGHT – HORIZONTAL										
23	24" x 8"	380.00	547.00	18.00	36.00	25.00	-34.00	182.00	349.00	49.00
24	24" x 10"	411.00	601.00	20.00	36.00	33.00	-38.00	200.00	390.00	53.00
25	27" x 8"	402.00	576.00	19.00	36.00	25.00	-34.00	189.00	363.00	49.00
26	27" x 10"	435.00	630.00	21.00	36.00	33.00	-38.00	209.00	404.00	53.00
2/1 LIGHT										
27	24" x 24"	390.00	640.00	22.00	36.00	34.00	-40.00	168.00	418.00	60.00
28	27" x 24"	411.00	669.00	22.00	36.00	34.00	-40.00	174.00	432.00	60.00
29	27" x 26"	444.00	642.00	23.00	36.00	35.00	-42.00	200.00	398.00	63.00
30	27" x 28"	460.00	725.00	24.00	36.00	53.00	-46.00	208.00	473.00	65.00
31	28" x 28"	462.00	731.00	25.00	36.00	53.00	-46.00	209.00	478.00	65.00
32	30" x 28"	503.00	760.00	25.00	36.00	53.00	-46.00	248.00	505.00	65.00
33	30" x 30"	465.00	778.00	25.00	36.00	55.00	-46.00	203.00	516.00	68.00
3/3 LIGHT										
34	9" x 12"	352.00	484.00	25.00	36.00	25.00	-34.00	149.00	281.00	46.00

- Mullion Unit (Single Unit times 2 plus)..... ADD \$ 15.00
 - Triple Unit (Single Unit times 3 plus) ADD 28.00
 - Quad Unit (Single Unit times 4 plus) ADD 40.00
 - Quint Unit (Single Unit times 5 plus)..... ADD 45.00
 - Add for *Single Stud Pocket* (per pocket) ADD 23.00
 - * Add for *Special Stud Pocket* (per pocket)..... ADD 31.00
 - Brasstone Sash Lock Applied - each..... ADD 17.00
- Double-Hung "Open Frame" Pricing - please call BROSCO office.

OPTIONAL CASING & OTHER OPTIONS - PAGE B-13

For Replacement Sash Kit**

ADD pair of Sash only **plus**
set Tilt 'n Clean Block & Tackle Balances **plus**
Sash Lock(s)
plus \$27.00

Shop Item – Allow additional time

Sash Locks (not applied)

White	\$4.70 each
Brasstone	\$21.90 each

Allow 2 sash locks for glass size 27" or wider

NOTES: * Not Applied. ** Head Parting Stop color matched to balances. * Mull casing not included.
 ◇ 3³/₄" Sill horns will be used unless otherwise specified.
 ♠ Extension Jamb(s) for Stud Pocket Units surround the individual units (sides & top).
 ♣ Extension Jamb adder applies to single units only. For all other configurations, see options page B-13.
 Units greater than 12'-0" width utilizing Composite or Cedar Flat Casing will have a butt joint.
 Items priced in *Italics* are Factory Order – Please allow additional lead time.

AUTHENTIC DIVIDED LIGHT (SSB or SSB w/Low "E" Panel)

Basic Unit Features:

- **Frame** – 4⁹/₁₆" Clear Side Jambs, Treated and Primed. **Composite Blind Stop.**
- **Sill** – **Composite Sill and Nosing.**
- **Casing** – **Composite Brickmould** standard.
- **Sash** – Wood Sash: 1³/₈" Thick, Putty Glazed with Single Thick Glass
Primed Exterior, Clear Pine Interior
or
Putty Glazed SSB Glass with Low "E" Energy Panel
- Tilt 'n Clean Block & Tackle Balance System with Vinyl Jamb Liners (specify beige or white)
- Weatherstripped Head Parting Stop
- Pine Inside Stops – Sides & Sill
- Cam Sash Lock applied (white)
2 per sash when glass size is 27" or wider

4/4 LIGHT

Rough Opening			1'-10"	
● Sash Opening			1'-7 ⁵ / ₈ "	
★ Glass Size			8"	
↓	↓	↓		
3'-5"	3'-1"	8"	1	8" x 8"
4'-1"	3'-9"	10"	2	8" x 10"
4'-5"	4'-1"	11"	3	8" x 11"
4'-9"	4'-5"	12"	4	8" x 12"

8/8 LIGHT

Rough Opening			2'-6"		2'-10"		3'-2"		3'-6"	
● Sash Opening			2'-3 ⁵ / ₈ "		2'-7 ⁵ / ₈ "		2'-11 ⁵ / ₈ "		3'-3 ⁵ / ₈ "	
★ Glass Size			6"		7"		8"		9"	
↓	↓	↓								
3'-5"	3'-1"	8"	10	6" x 8"	12	8" x 8"				
3'-9"	3'-5"	9"			11	7" x 9"				
4'-1"	3'-9"	10"					13	8" x 10"		
4'-5"	4'-1"	11"					14	8" x 11"	16	9" x 11"
4'-9"	4'-5"	12"					15	8" x 12"	17	9" x 12"

6/1 LIGHT

Rough Opening			2'-9"	
● Sash Opening			2'-6 ⁵ / ₈ "	
★ Glass Size			27"	
↓	↓	↓		
4'-1"	3'-9"	20"	5	27" x 20"
4'-5"	4'-1"	22"	6	27" x 22"
4'-9"	4'-5"	24"	7	27" x 24"
5'-1"	4'-9"	26"	8	27" x 26"
5'-5"	5'-1"	28"	9	27" x 28"

9/9 LIGHT

Rough Opening			2'-3"	
● Sash Opening			2'-0 ⁵ / ₈ "	
★ Glass Size			7"	
↓	↓	↓		
4'-9"	4'-5"	8"		
5'-3"	4'-11"	9"	18	7" x 9"
5'-9"	5'-5"	10"		

12/12 LIGHT

Rough Opening			2'-6"		2'-10"		3'-2"	
● Sash Opening			2'-3 ⁵ / ₈ "		2'-7 ⁵ / ₈ "		2'-11 ⁵ / ₈ "	
★ Glass Size			6"		7"		8"	
↓	↓	↓						
4'-9"	4'-5"	8"	19	6" x 8"				
5'-3"	4'-11"	9"			20	7" x 9"		
5'-9"	5'-5"	10"					21	8" x 10"

COTTAGE STYLE (unevenly divided)

Rough Opening			2'-3"		2'-3"		2'-6"		2'-6"		2'-6"		2'-10"		2'-10"	
● Sash Opening			2'-0 ⁵ / ₈ "		2'-0 ⁵ / ₈ "		2'-3 ⁵ / ₈ "		2'-3 ⁵ / ₈ "		2'-3 ⁵ / ₈ "		2'-7 ⁵ / ₈ "		2'-7 ⁵ / ₈ "	
★ Glass Size			7"		7"		8"		8"		6"		7"		7"	
↓	↓	↓														
4'-1"	3'-9"	8"									26	6" x 8"				
4'-6"	4'-2"	9"	22	7" x 9"	23	7" x 9"							27	7" x 9"	28	7" x 9"
4'-11"	4'-7"	10"					24	8" x 10"	25	8" x 10"						

Maximize your window's performance by adding a LARSON® Storm Window – See LARSON Storm & Venting Products (Tab LAR)

● Actual sash width = sash opening width minus 1⁹/₁₆".
★ Glass sizes are approximate.

Illustrations not to scale.



BROSCO SSB Window Unit

PRICING



AUTHENTIC DIVIDED LIGHT (SSB or SSB w/Low "E" Panel)

Unit Description (Glass Size)	Wood Sash		Set-Up Unit Options				Replacement		
	Single Thick Glass SSB w/Brickmould	Single Thick Glass SSB w/Low-E Panel w/Brickmould	*ADD Full Screen (White Frame)	ADD 6 ⁹ / ₁₆ " Ext. Jamb (Applied) ♠ ♣	ADD Composite Flat Casing 1 ¹ / ₁₆ " x 3 ³ / ₄ "	◇ DEDUCT No Casing	Sash Only SSB Glass	Sash Only SSB w/Low-E Energy Panel	Tilt 'n Clean Block & Tackle Balances Only (White or Beige)
4/4 LIGHT									
1 8" x 8"	\$336.00	\$477.00	\$16.00	\$36.00	\$25.00	-\$34.00	\$148.00	\$289.00	\$49.00
2 8" x 10"	381.00	526.00	17.00	36.00	33.00	-38.00	180.00	325.00	53.00
3 8" x 11"	393.00	547.00	32.00	36.00	33.00	-38.00	188.00	342.00	56.00
4 8" x 12"	408.00	573.00	19.00	36.00	34.00	-40.00	196.00	361.00	60.00
6/1 LIGHT									
5 27" x 20"	403.00	641.00	21.00	36.00	33.00	-38.00	177.00	415.00	53.00
6 27" x 22"	415.00	664.00	22.00	36.00	33.00	-38.00	185.00	434.00	56.00
7 27" x 24"	429.00	602.00	22.00	36.00	34.00	-40.00	192.00	365.00	60.00
8 27" x 26"	445.00	720.00	23.00	36.00	35.00	-42.00	201.00	476.00	63.00
9 27" x 28"	479.00	747.00	24.00	36.00	53.00	-46.00	227.00	495.00	65.00
8/8 LIGHT									
10 6" x 8"	399.00	519.00	18.00	36.00	25.00	-34.00	201.00	321.00	49.00
11 7" x 9"	434.00	572.00	20.00	36.00	29.00	-34.00	215.00	353.00	52.00
12 8" x 8"	453.00	617.00	21.00	36.00	25.00	-34.00	235.00	399.00	49.00
13 8" x 10"	463.00	664.00	22.00	36.00	33.00	-38.00	232.00	433.00	53.00
14 8" x 11"	474.00	685.00	23.00	36.00	33.00	-38.00	239.00	450.00	56.00
15 8" x 12"	490.00	711.00	24.00	36.00	34.00	-40.00	248.00	469.00	60.00
16 9" x 11"	510.00	764.00	36.00	36.00	33.00	-38.00	270.00	534.00	56.00
17 9" x 12"	502.00	791.00	25.00	36.00	34.00	-40.00	255.00	544.00	60.00
9/9 LIGHT									
18 7" x 9"	484.00	642.00	36.00	36.00	53.00	-46.00	252.00	410.00	63.00
12/12 LIGHT									
19 6" x 8"	490.00	638.00	22.00	36.00	34.00	-40.00	268.00	416.00	60.00
20 7" x 9"	539.00	707.00	24.00	36.00	53.00	-46.00	288.00	456.00	63.00
21 8" x 10"	600.00	824.00	36.00	36.00	55.00	-46.00	336.00	560.00	72.00
COTTAGE STYLE									
22 7" x 9" (6/9)	435.00	574.00	20.00	36.00	33.00	-39.00	220.00	359.00	60.00
23 7" x 9" (9/6)	435.00	574.00	20.00	36.00	33.00	-39.00	220.00	359.00	60.00
24 8" x 10" (6/9)	465.00	664.00	36.00	36.00	33.00	-42.00	237.00	436.00	63.00
25 8" x 10" (9/6)	465.00	628.00	22.00	36.00	33.00	-42.00	237.00	400.00	63.00
26 6" x 8" (8/12)	444.00	629.00	20.00	36.00	33.00	-38.00	233.00	418.00	55.00
27 7" x 9" (8/12)	485.00	690.00	32.00	36.00	33.00	-39.00	251.00	456.00	60.00
28 7" x 9" (12/8)	508.00	677.00	36.00	36.00	33.00	-39.00	274.00	443.00	60.00

- Mullion Unit (Single Unit times 2 plus)..... ADD \$ 15.00
 - Triple Unit (Single Unit times 3 plus) ADD 28.00
 - Quad Unit (Single Unit times 4 plus) ADD 40.00
 - Quint Unit (Single Unit times 5 plus)..... ADD 45.00
 - Add for *Single Stud Pocket* (per pocket) ADD 23.00
 - * Add for *Special Stud Pocket* (per pocket)..... ADD 31.00
 - Brasstone Sash Lock Applied - each ADD 17.00
- Double-Hung "Open Frame" Pricing - please call BROSCO office.

OPTIONAL CASING & OTHER OPTIONS - PAGE B-13

For Replacement Sash Kit**

ADD pair of Sash only plus
set Tilt 'n Clean Block & Tackle Balances plus
Sash Lock(s)
plus \$27.00

Shop Item – Allow additional time

Sash Locks (not applied)

White	\$4.70 each
Brasstone	\$21.90 each

Allow 2 sash locks for glass size 27" or wider

NOTES: * Not Applied. ** Head Parting Stop color matched to balances. * Mull casing not included.

◇ 3³/₄" Sill horns will be used unless otherwise specified.

♠ Extension Jamb for Stud Pocket Units surround the individual units (sides & top).

♣ Extension Jamb adder applies to single units only. For all other configurations, see options page B-13.

Units greater than 12'-0" width utilizing Composite or Cedar Flat Casing will have a butt joint.

Items priced in *Italics* are Factory Order – Please allow additional lead time.

AUTHENTIC DIVIDED LIGHT (SSB)

Basic Unit Features:

- **Frame** – 4⁹/₁₆" Clear Side Jambs, Treated and Primed. **Composite Blind Stop.**
 - **Sill** – **Composite Sill and Nosing.**
 - **Casing** – **Composite Brickmould** standard.
 - **Sash** – Wood Sash: 1³/₈" Thick, Putty Glazed with Single Thick Glass. Primed Exterior, Clear Pine Interior
- Composite Picture Stops – Head & Sides
 - Interior Sash Stops by others

STATIONARY PICTURE WINDOWS

Rough Opening			3'-6 1/8"	3'-10 1/2"	4'-6 1/2"	5'-2 1/2"	5'-10 1/2"					
Sash Opening			3'-3 5/8"	3'-8"	4'-4"	5'-0"	5'-8"					
★ Glass Size			9"	10"	9"	9"	8"					
			16 Light	16 Light	20 Light	24 Light	32 Light					
3'-5"	3'-1"	8"	—	3	3'-8" x 3'-1"	8	4'-4" x 3'-1"	—	—			
4'-1"	3'-9"	10"	—	4	3'-8" x 3'-9"	9	4'-4" x 3'-9"	13	5'-0" x 3'-9"	17	5'-8" x 3'-9"	
4'-5"	4'-1"	11"	1	3'-3 ⁵ / ₈ " x 4'-1"	5	3'-8" x 4'-1"	10	4'-4" x 4'-1"	14	5'-0" x 4'-1"	18	5'-8" x 4'-1"
4'-9"	4'-5"	12"	2	3'-3 ⁵ / ₈ " x 4'-5"	6	3'-8" x 4'-5"	11	4'-4" x 4'-5"	15	5'-0" x 4'-5"	19	5'-8" x 4'-5"
5'-1"	4'-9"	13"	—	7	3'-8" x 4'-9"	12	4'-4" x 4'-9"	16	5'-0" x 4'-9"	20	5'-8" x 4'-9"	

Maximize your window's performance by adding a LARSON® Storm Window – See LARSON Storm & Venting Products (Tab LAR)

Low "E" Panels not available for Picture Windows.

★ Glass sizes are approximate.

Set-Up Picture Units with Brickmould Casing						REPLACEMENT
Unit Description (Sash Opening)	Wood Sash	Set-Up Unit Options			Replacement Sash Only	
	Basic Picture Unit w/Brickmould	ADD 6 ⁹ / ₁₆ " Ext. Jambs (Applied) ♣	ADD Composite Flat Casing 1 ¹ / ₁₆ " x 3 ³ / ₄ "	◇ DEDUCT No Casing		
	1	3'-3 ⁵ / ₈ " x 4'-1"	\$ 757.00	\$66.00		\$33.00
2	3'-3 ⁵ / ₈ " x 4'-5"	776.00	66.00	34.00	-40.00	476.00
3	3'-8" x 3'-1"	<i>828.00</i>	66.00	29.00	-51.00	<i>464.00</i>
4	3'-8" x 3'-9"	827.00	66.00	37.00	-55.00	459.00
5	3'-8" x 4'-1"	<i>887.00</i>	66.00	37.00	-55.00	<i>519.00</i>
6	3'-8" x 4'-5"	<i>907.00</i>	66.00	38.00	-57.00	<i>537.00</i>
7	3'-8" x 4'-9"	882.00	66.00	39.00	-59.00	510.00
8	4'-4" x 3'-1"	<i>842.00</i>	66.00	29.00	-51.00	<i>478.00</i>
9	4'-4" x 3'-9"	879.00	66.00	37.00	-55.00	511.00
10	4'-4" x 4'-1"	<i>897.00</i>	66.00	37.00	-55.00	<i>529.00</i>
11	4'-4" x 4'-5"	<i>965.00</i>	66.00	38.00	-57.00	<i>595.00</i>
12	4'-4" x 4'-9"	955.00	66.00	39.00	-59.00	583.00
13	5'-0" x 3'-9"	<i>933.00</i>	66.00	37.00	-55.00	<i>565.00</i>
14	5'-0" x 4'-1"	<i>951.00</i>	66.00	37.00	-55.00	<i>583.00</i>
15	5'-0" x 4'-5"	<i>969.00</i>	66.00	38.00	-57.00	<i>599.00</i>
16	5'-0" x 4'-9"	1046.00	66.00	39.00	-59.00	674.00
17	5'-8" x 3'-9"	<i>1076.00</i>	66.00	37.00	-55.00	<i>695.00</i>
18	5'-8" x 4'-1"	<i>1036.00</i>	66.00	37.00	-55.00	<i>655.00</i>
19	5'-8" x 4'-5"	<i>1116.00</i>	66.00	38.00	-57.00	<i>733.00</i>
20	5'-8" x 4'-9"	1136.00	66.00	39.00	-59.00	751.00

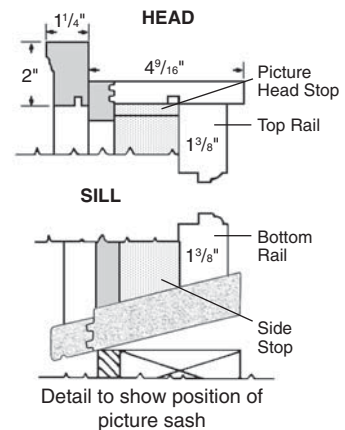

Picture Sash – Shipped loose in frame to facilitate unit installation.

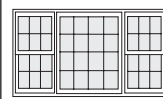

To price Picture Unit w/Double-Hung Flankers – Single Unit times 2 plus Picture Unit plus Triple Mull charge.

For Optional Casings and other options (including 6⁹/₁₆" Extension Jambs) – Page B-13.

- NOTES:** ◇ 3³/₄" Sill horns will be used unless otherwise specified.
- ♣ Extension Jambs for Stud Pocket Units surround the individual units (sides & top).
 - ♠ Extension Jamb adder applies to single units only. For all other configurations, see options page B-13. Units greater than 12'-0" width utilizing Composite or Cedar Flat Casing will have a butt joint. Items priced in *Italics* are Factory Order – Please allow additional lead time.



BROSCO SSB Window Unit TRANSOMS



AUTHENTIC DIVIDED LIGHT (SSB)

BROSCO Transom Units are completely assembled and mulled above BROSCO Double-Hung Units. If a "stand alone" Unit is desired, please see B-12 for BROSCO Stationary Windows.

3 LIGHT RECTANGULAR TRANSOM

Rough Opening	2'-0"	2'-3"	2'-6"	2'-9"	3'-0"
★Glass Size	6"	7"	8"	9"	10"
Varies †	8"	6" x 8"			
	9"		7" x 9"		
	10"			8" x 10"	9" x 10"
					10" x 10"

4 LIGHT RECTANGULAR TRANSOM

Rough Opening	2'-6"	2'-10"	3'-2"	3'-6"
★Glass Size	6"	7"	8"	9"
Varies †	8"	6" x 8"		
	9"		7" x 9"	
	10"			8" x 10"
	12"			9" x 12"

6 LIGHT RECTANGULAR TRANSOM

Rough Opening	2'-3"	2'-6"	2'-9"	3'-0"
★Glass Size	7"	8"	9"	10"
Varies †	9"	7" x 9"	8" x 9"	9" x 9"
				10" x 9"

Set-up Transom Frame	\$265.00
Applied Optional Extras:	
Composite Brickmould Casing	62.00
Composite Cape Cod Flat Casing 1 ¹ / ₁₆ " x 4 ¹ / ₂ "	66.00
Composite Flat Casing 1 ¹ / ₁₆ " x 3 ³ / ₄ "	108.00
Primed Wood Flat Casing 1 ¹ / ₁₆ " x 5 ¹ / ₄ "	98.00
Cedar Flat Casing 1 ¹ / ₁₆ " x 3 ³ / ₄ "	252.00
6 ⁹ / ₁₆ " Extension Jambs	66.00

Glass size noted under each illustration indicates Double-Hung size to be used with corresponding Transom.

★ Glass sizes are approximate.

† Combined Transom/Double-Hung rough opening height formula: Transom glass height plus overall Double-Hung glass height plus 13¹/₄".

HOW-TO-ORDER

1. Start with Double-Hung unit of your choice
 - A. Deduct for No Casing
 - B. Add for Accessories (Screens, Grilles, etc.)
2. Add for Cellar Sash (pair) of your choice (specify SSB or SSB w/Low "E" Panel)
3. Add "Set-up Transom Frame" charge
4. Add for complete unit casing
5. Select wall thickness (4⁹/₁₆" standard, 6⁹/₁₆" optional)

PRICING EXAMPLE

1. 8 x 10 6/6 Authentic Divided Light unit w/Low "E" Energy Panel (page B-5)	\$ 547.00
A. No Casing	DEDUCT -38.00
B. Full Screen	ADD 20.00
2. 8 x 10 6/6 Authentic Divided Light Sash only w/Low "E" Energy Panel (page B-5)	
(pair price)	ADD 336.00
3. Set-up Transom Frame (see above)	ADD 265.00
4. Brickmould Casing (see above)	ADD 62.00
5. 6 ⁹ / ₁₆ " Extension Jambs (see above)	ADD 66.00
	TOTAL \$1258.00

Illustrations not to scale.

BROSCO Stationary Window Units are for those applications where a "stand alone" stationary unit is desired.
Transom Units for BROSCO Double-Hung Windows – see page B-11.

Set-up Stationary Window Unit with Standard Double-Hung Sill and Brickmould Casing

EXAMPLE:

- | | |
|--|-------------|
| 1. Sash ONLY | 1. \$ _____ |
| a. Sash, SSB or SSB w/Low "E" Panel (pair price) | |
| or | |
| b. Cellar Sash ONLY | |
| 2. Set-up Stationary Frame with Primed Brickmould Casing:
(select an overall glass width below) | 2. _____ |

Overall Glass Width									
16"	18"	20"	21"	24"	27"	28"	30"	32"	36"
\$168.00	\$172.00	\$174.00	\$175.00	\$178.00	\$181.00	\$182.00	\$184.00	\$186.00	\$191.00
Modular Sash Size									
1-4	1-8	1-10	2-0	2-4	2-7	2-8	2-10	3-0	
\$168.00	\$172.00	\$174.00	\$175.00	\$181.00	\$182.00	\$184.00	\$186.00	\$191.00	

- | | |
|---|---------------|
| 3. Casing Options: | 3. _____ |
| a. Extra for Composite Cape Cod Flat Casing $1\frac{1}{16}" \times 4\frac{1}{2}"$ | 36.00 |
| b. Extra for Composite Flat Casing $1\frac{1}{16}" \times 3\frac{3}{4}"$ | 42.00 |
| c. Extra for Primed Wood Flat Casing $1\frac{1}{16}" \times 5\frac{1}{4}"$ | 16.00 |
| d. Extra for Cedar Sill & Cedar Flat Casing $1\frac{1}{16}" \times 3\frac{3}{4}"$ | 121.00 |
| e. DEDUCT for No Casing | -37.00 |
| 4. ADD for $6\frac{9}{16}"$ Extension Jambes - applied | 36.00 |

Stationary Window Unit Rough Openings & Unit Dimensions	SSB Glass & SSB w/Low "E" Panel		Cellar Sash	
	Width	Height	Width	Height
Rough Opening = Glass plus	6"	$6\frac{5}{16}"$	6"	$6\frac{3}{16}"$
Unit Dimension = Glass plus	$4\frac{7}{8}"$	$5\frac{3}{16}"$	$4\frac{7}{8}"$	$5\frac{5}{8}"$
Brickmould Casing = Glass plus	$7\frac{5}{8}"$	$7\frac{5}{16}"$	$7\frac{5}{8}"$	$7\frac{7}{16}"$
Flat Casing $3\frac{3}{4}"$ = Glass plus	11"	$8\frac{7}{8}"$	11"	$9\frac{3}{16}"$
Flat Casing $5\frac{1}{4}"$ = Glass plus	14"	$10\frac{3}{8}"$	14"	$10\frac{11}{16}"$
Flat Casing $4\frac{1}{2}"$ = Glass plus	$12\frac{3}{4}"$	$9\frac{7}{16}"$	$12\frac{3}{4}"$	$9\frac{15}{16}"$

Total \$ _____



w/Brickmould

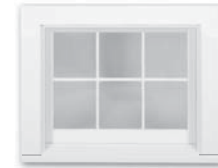

w/Flat Casing

HOW TO MEASURE FOR REPLACEMENT SASH

From inside the house, first measure the width of the window sash you are replacing. Measure from inside the window opening from jamb to jamb (wood to wood).

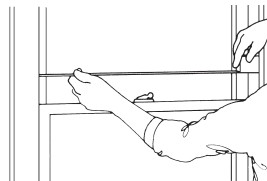

Measure the width of your old window opening

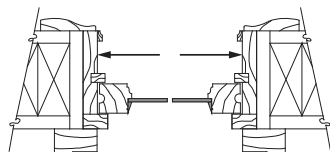

Sash opening width

Be sure to measure from the surface of one side jamb to the other, not from the stop or parting bead.



Measure the height of your old window opening

To measure window opening height, lower the top sash a few inches and "thread" your tape measure between the sash.

Carefully measure the window height from the point where the top sash meets the head jamb to the point where the exterior of the bottom sash meets the sill.

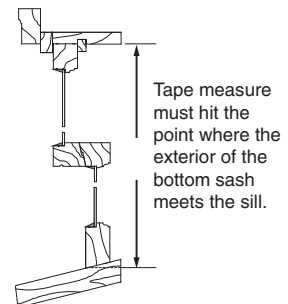

Tape measure must hit the point where the exterior of the bottom sash meets the sill.



BROSCO SSB Window Unit OPTIONS



Casing Options	Single	Mullion	Triple	Quad	Quint	Stat Picture	Picture w/Flankers
COMPOSITE CAPE COD FLAT CASING 1 ¹ / ₁₆ " x 4 ¹ / ₂ " (ADD to price of a Basic Unit with BRICKMOULD)	\$ 24.00	\$ 26.00	\$ 33.00	\$ 37.00	\$ 45.00	\$ 19.00	\$ 33.00
PRIMED WOOD FLAT CASING 1 ¹ / ₁₆ " x 5 ¹ / ₄ " (ADD to price of a Basic Unit with FLAT CASING)							
HEAD ONLY with 1 ¹ / ₁₆ " x 3 ³ / ₄ " COMPOSITE SIDES	3.00	3.00	4.00	3.00	3.75	34.00	4.00
HEAD and SIDES (Includes add for appropriate Long Sill Horns)	26.00	35.00	36.00	35.00	45.75	57.00	36.00
CEDAR SILL and CEDAR FLAT CASING * (ADD to price of a Basic Unit with BRICKMOULD)							
1 ¹ / ₁₆ " x 3 ³ / ₄ " HEAD & SIDES	144.00	319.00	460.00	626.00	792.50	250.00	460.00
ADD for Rip FLAT CASING (specify "Rip To" Width):	27.00	27.00	27.00	27.00	27.00	27.00	27.00

Sill Options	Single	Mullion	Triple	Quad	Quint	Stat Picture	Picture w/Flankers
"HISTORIC" SILL NOSING (see Page BI-3)							
– COMPOSITE	\$26.00	\$ 50.00	\$ 70.00	\$ 77.00	\$106.00	\$ 50.00	\$ 70.00
– CEDAR ‡	87.00	115.00	144.00	217.00	313.00	115.00	144.00
LONG SILL HORNS (OVER 4 ¹ / ₂ " thru 10") – COMPOSITE	27.00	36.00	36.00	36.00	46.00	27.00	36.00
(ADD to price of a unit with "No Casing") – CEDAR ‡	47.00	51.00	51.00	51.00	93.00	51.00	51.00
CEDAR SILL and STANDARD CEDAR NOSING ONLY (w/Composite Brickmould Casing)							
(ADD to price of a Basic Unit with BRICKMOULD)	59.00	138.00	191.00	288.00	370.00	173.00	191.00

Miscellaneous Options	Single	Mullion	Triple	Quad	Quint	Stat Picture	Picture w/Flankers
BRASSTONE SASH LOCKS (Applied):	\$17.00	\$34.00	\$ 51.00	\$ 68.00	\$ 85.00	–	\$ 34.00
For units with glass 27" or wider: Times 2							
EXTENSION JAMBS APPLIED (6⁹/₁₆" Wall)							
– NARROW	36.00	66.00	81.00	98.00	108.00	\$66.00	81.00
– w/STUD POCKET ♠	–	72.00	108.00	144.00	180.00	–	108.00
ADD for Stainless Steel Nails (Composite or Primed Casing)		\$11.00					

* Cedar Casing option includes Stainless Steel Fasteners.

♠ Extension Jambs for Stud Pocket Units surround the individual units (sides & top).

‡ Cedar Nosing options are only compatible with Cedar Sill options.

Units greater than 12'-0" width utilizing Composite or Cedar Flat Casing will have a butt joint.

BROSCO Putty Glazed SSB Double-Hung Window

BROSCO Putty Glazed SSB Picture Window

BROSCO Putty Glazed SSB Window with Low-E Energy Panel

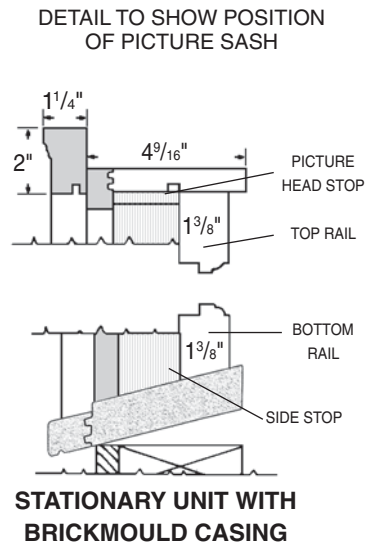
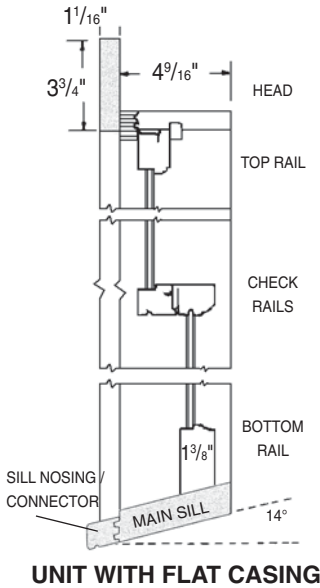
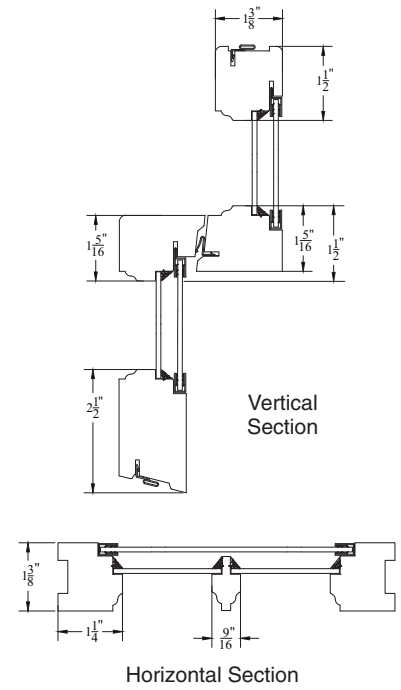
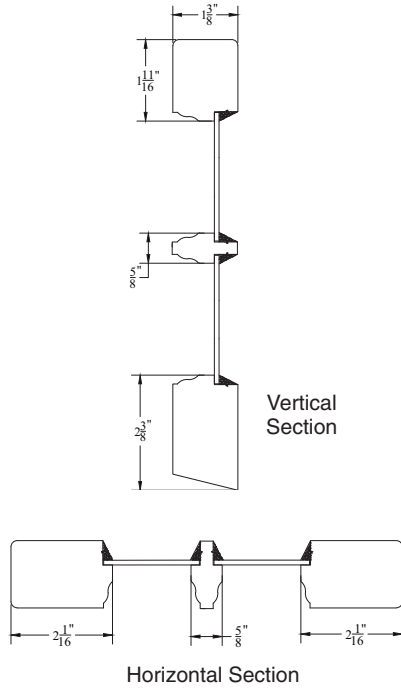
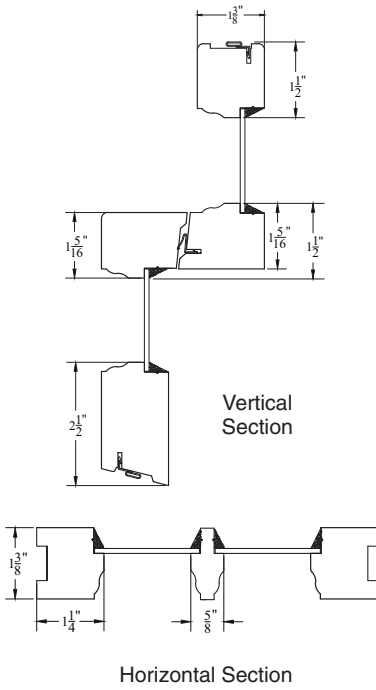

Replacement Sill
1 1/4" x 6 1/4"
(1 piece - "A" Grade)

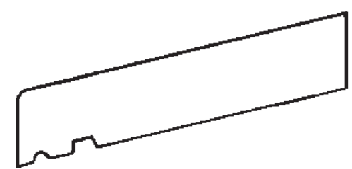

*See Moulding Section (Tab M)
for Replacement Sill pricing.*

Side Jambs	1 1/16" x 4 9/16"
Head Jamb	1 1/16" x 4 9/16"
Main Sill Composite	1 1/4" x 4 3/4"
Main Sill Cedar	1 1/4" x 4 3/4"
Sill Nosing / Connector - Composite	1 3/16" x 1 1/2"
Sill Nosing / Connector - Cedar	1 1/4" x 2"
Sill Nosing / Connector - "Historic" Composite	1 5/8" x 1 3/4"
Sill Nosing / Connector - "Historic" Cedar	1 3/4" x 2 1/4"
Mullion Casing for Standard (Narrow) Mullion	1 1/16" x 1 5/16"
Mullion Casing for Single Stud Pocket Mullion	1 1/16" x 3 1/2"

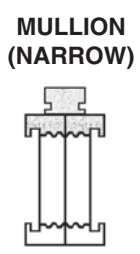



Cellar Sash and Frames (Sash 1 1/8" Thick)

PINE (Unprimed)



3 Light



THREE LIGHT			
Glass Size	Outside Dimensions	Sash	K.D. Pine Frame (No Casing)
6" x 8"	1'-9 5/8" x 0'-11 1/4"	\$56.00	\$49.00
7" x 9"	2'-0 5/8" x 1'-0 1/4"	61.00	55.00
8" x 10"	2'-3 5/8" x 1'-1 1/4"	66.00	57.00
	1'-3 1/4"	68.00	60.00
9" x 7"	2'-6 5/8" x 0'-10 1/4"	66.00	60.00
	1'-0 1/4"	68.00	62.00
	1'-1 1/4"	69.00	62.00
	1'-2 1/4"	71.00	64.00
	1'-3 1/4"	71.00	65.00
	1'-4 1/4"	73.00	66.00
	1'-5 1/4"	75.00	67.00
	1'-6 1/4"	75.00	68.00
10" x 8"	2'-9 5/8" x 0'-11 1/4"	71.00	65.00
	1'-1 1/4"	73.00	66.00
	1'-3 1/4"	75.00	69.00
	1'-4 1/4"	76.00	70.00
	1'-5 1/4"	78.00	71.00
	1'-6 1/4"	80.00	72.00
	1'-7 1/4"	80.00	73.00
	1'-8 1/4"	82.00	74.00
11" x 15"	3'-0 5/8" x 1'-6 1/4"	83.00	76.00
	1'-9 1/4"	87.00	79.00
12" x 14"	3'-3 5/8" x 1'-5 1/4"	85.00	79.00
	1'-7 1/4"	88.00	81.00
	1'-9 1/4"	90.00	83.00

4 Light Long

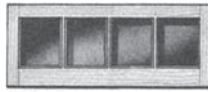

Low "E" panels not available



4 Light Square

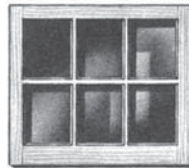

6 Light

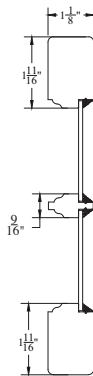

FOUR LIGHT - LONG			
Glass Size	Outside Dimensions	Sash	K.D. Pine Frame (No Casing)
6" x 8"	2'-3 5/8" x 0'-11 1/4"	\$67.00	\$56.00
7" x 9"	2'-7 5/8" x 1'-0 1/4"	73.00	62.00
8" x 10"	2'-11 5/8" x 1'-1 1/4"	79.00	68.00
	1'-3 1/4"	82.00	71.00
9" x 12"	3'-3 5/8" x 1'-3 1/4"	87.00	77.00
10" x 12"	3'-7 5/8" x 1'-3 1/4"	92.00	85.00
	1'-7 1/4"	97.00	89.00

FOUR LIGHT - SQUARE			
Glass Size	Outside Dimensions	Sash	K.D. Pine Frame (No Casing)
6" x 8"	1'-3 3/8" x 1'-7 1/4"	\$61.00	-
7" x 9"	1'-5 3/8" x 1'-9 1/4"	67.00	\$51.00
8" x 10"	1'-7 3/8" x 1'-11 1/4"	72.00	57.00
	2'-3 1/4"	77.00	61.00
9" x 12"	1'-9 3/8" x 2'-3 1/4"	79.00	65.00
	2'-5 1/4"	82.00	66.00
10" x 12"	1'-11 3/8" x 2'-3 1/4"	82.00	68.00
	2'-5 1/4"	84.00	69.00
	2'-9 1/4"	89.00	74.00

SIX LIGHT			
Glass Size	Outside Dimensions	Sash	K.D. Pine Frame (No Casing)
6" x 8"	1'-9 5/8" x 1'-7 1/4"	\$ 78.00	\$57.00
7" x 9"	2'-0 5/8" x 1'-9 1/4"	83.00	64.00
8" x 10"	2'-3 5/8" x 1'-11 1/4"	90.00	68.00
	2'-1 1/4"	92.00	69.00
9" x 11"	2'-6 5/8" x 2'-1 1/4"	97.00	74.00
	2'-3 1/4"	99.00	77.00
12" x 13"	2'-5 1/4"	100.00	78.00
	2'-7 1/4"	104.00	81.00
15" x 10"	2'-9 5/8" x 1'-11 1/4"	97.00	77.00
	2'-3 1/4"	102.00	81.00
13" x 14"	2'-5 1/4"	106.00	82.00
	2'-7 1/4"	107.00	85.00
15" x 16"	2'-9 1/4"	110.00	87.00
	2'-11 1/4"	112.00	88.00

For Cellar Frame Rough Opening
ADD 6" to total glass width and height.

Example: 6 x 8 3 Lights

3 x 6 = 18" + 6" = 24"

8" Height + 6" = 14" R.O. 2'-0" x 1'-2"

CELLAR FRAMES (Heads and Sills only)			
Glass Width	Lights Wide	Sash Size Width	List Price (Set)
7"	2 Lt.	1'-5 3/8"	\$27.00
8"	"	1'-7 3/8"	31.00
9"	"	1'-9 5/8"	35.00
10"	"	1'-11 3/8"	38.00
6"	3 Lt.	1'-9 5/8"	35.00
7"	"	2'-0 5/8"	40.00
8"	"	2'-3 5/8"	42.00
9"	"	2'-6 5/8"	47.00
10"	"	2'-9 5/8"	51.00
11"	"	3'-0 5/8"	55.00
12"	"	3'-3 5/8"	59.00
6"	4 Lt.	2'-3 5/8"	42.00
7"	"	2'-7 5/8"	47.00
8"	"	2'-11 5/8"	53.00
9"	"	3'-3 5/8"	59.00
10"	"	3'-7 5/8"	67.00

CELLAR SASH FRAMES

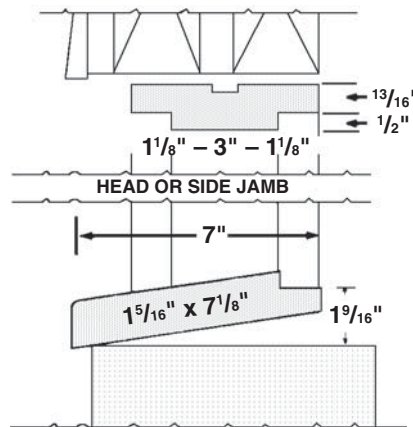

CELLAR FRAMES (Sides only)			
Glass Width	Lights High	Sash Size Height	List Price (Pair)
7"	1 Lt.	0'-10 1/4"	\$13.00
8"	"	0'-11 1/4"	14.00
9"	"	1'-0 1/4"	15.00
10"	"	1'-1 1/4"	15.00
11"	"	1'-2 1/4"	17.00
12"	"	1'-3 1/4"	18.00
13"	"	1'-4 1/4"	19.00
14"	"	1'-5 1/4"	20.00
15"	"	1'-6 1/4"	21.00
16"	"	1'-7 1/4"	22.00
18"	"	1'-9 1/4"	24.00
20"	"	1'-11 1/4"	26.00
8"	2 Lt.	1'-7 1/4"	22.00
9"	"	1'-9 1/4"	24.00
10"	"	1'-11 1/4"	26.00
11"	"	2'-1 3/8"	27.00
12"	"	2'-3 3/8"	30.00
13"	"	2'-5 3/8"	31.00
14"	"	2'-7 3/8"	34.00
15"	"	2'-9 3/8"	36.00
16"	"	2'-11 3/8"	37.00

NOTES: Sash and frames are unprimed and treated with a preservative which acts as a moisture repellent and protects against decay. Not all sash stocked at all locations.



1 Light

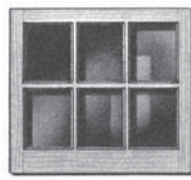

6 Light

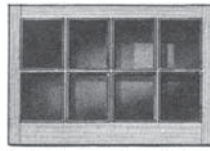

8 Light

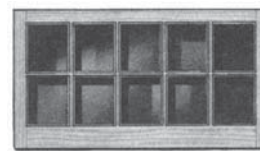

10 Light

GLAZED SINGLE SASH 1³/₈" THICK

Sash Size	1 Light	6 Light	8 Light	10 Light	ADD For K.D. Frame Only (No Casing)	Rough Opening
2'-0" x 2'-0"	\$ 83.00	\$ 96.00	—	—	\$138.00	2'-2 ¹ / ₂ " x 2'- 4"
2'-6" x 2'-0"	93.00	107.00	—	—	144.00	2'-8 ¹ / ₂ " x 2'- 4"
2'-6" x 2'-6"	104.00	117.00	—	—	144.00	2'-8 ¹ / ₂ " x 2'-10"
3'-0" x 2'-0"	104.00	—	\$123.00	—	154.00	3'-2 ¹ / ₂ " x 2'- 4"
4'-0" x 2'-0"	—	—	—	\$155.00	349.00	4'-2 ¹ / ₂ " x 2'- 4"



6 Light



8 Light

9 LIGHT BARN SASH – 1¹/₈" THICK

Glass Size	Outside Dimensions	Sash
9" x 12"	2'-6 ⁵ / ₈ " x 3'-3 ⁵ / ₈ "	\$127.00
10" x 12"	2'-9 ⁵ / ₈ " x 3'-3 ⁵ / ₈ "	133.00

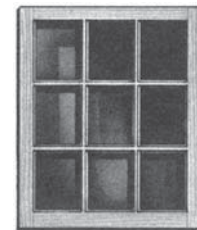

9 Light

SINGLE CASEMENT SASH 1³/₈" THICK

Size		Glazed
1'-4" x 2'-6"	6 Light	\$ 93.00
3'-0"	"	103.00
3'-6"	"	114.00
1'-6" x 2'-6"	"	96.00
3'-0"	"	107.00
3'-6"	"	117.00
2'-0" x 3'-0"	"	117.00
1'-4" x 4'-0"	8 Light	130.00
4'-6"	"	139.00
1'-6" x 4'-0"	"	132.00
4'-6"	"	142.00
2'-0" x 4'-0"	"	145.00
4'-6"	"	154.00

For Single Sash Set-up in Stationary Frame - see page B-12.

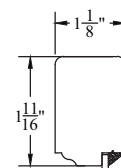

Barn & Cellar Sash

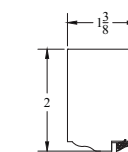

Single & Casement Sash

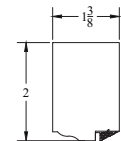

Wood Skylight Sash

★ Muntin Bar:
Unprimed - 9/16"
Primed - 5/8"

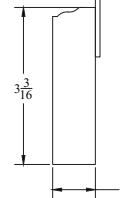
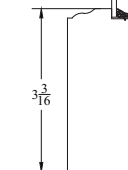
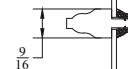
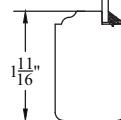

NOTES: Single Casement Sash are not rabbeted. (Frames not available for these sash.)



Cellar, Barn and Single Sash PRIMED



1 1/8" GLAZED CELLAR AND BARN SASH — PRIMED TWO SIDES

CELLAR SASH PRIMED TWO SIDES

BARN SASH PRIMED TWO SIDES



3 Light

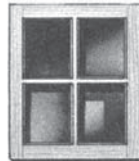

4 Light Square

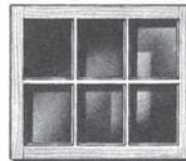

6 Light
(3 wide)



6 Light
(2 wide)

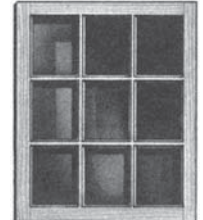

9 Light

CELLAR SASH					
3 Light		4 Light — Square		6 Light — 3 Wide	
Size	List Price	Size	List Price	Size	List Price
2'- 0" x 1'-0"	\$57.00	1'- 4" x 1'-9"	\$63.00	2'-0" x 1'-11"	\$ 83.00
2'- 4" x 1'-4"	68.00	1'- 8" x 2'-1"	73.00	2'-4" x 2'-1"	92.00
		2'-5"	79.00	2'-5"	97.00
2'- 7" x 1'-5"	73.00	2'- 0" x 2'-1"	79.00	2'-7" x 2'-5"	100.00
		2'-5"	84.00	2'-7"	102.00
2'- 8" x 1'-0"	68.00	2'-9"	89.00	2'-8" x 2'-5"	100.00
1'-4"	73.00			2'-7"	104.00
1'-8"	78.00			2'-9"	106.00
2'-10" x 1'-5"	76.00			2'-10" x 2'-5"	104.00
1'-7"	80.00			2'-9"	109.00
1'-9"	81.00			3'-0" x 2'-5"	106.00
3'- 0" x 1'-4"	78.00			3'-1"	116.00

BARN SASH 6 Light — 2 Wide	
Size	List Price
1'- 8" x 2'-11 1/4"	\$ 95.00
3'- 5 1/4"	102.00
1'-10" x 3'- 5 1/4"	106.00
2'- 0" x 3'- 5 1/4"	107.00
9 Light	
Size	List Price
2'- 4" x 2'-11 1/4"	\$118.00
3'- 5 1/4"	125.00
2'- 8" x 3'- 5 1/4"	130.00
3'- 0" x 3'- 5 1/4"	135.00

1 3/8" GLAZED SINGLE SASH

EXTERIOR FACE PRIMED



1 Light

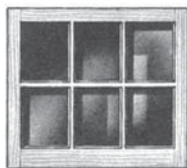

6 Light

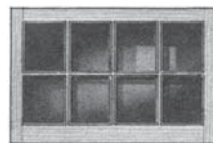

8 Light

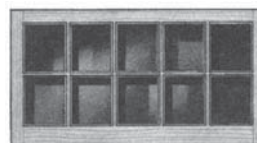

10 Light

SIZE	SINGLE SASH			
	1 Light	6 Light	8 Light	10 Light
2'-0" x 2'-0"	\$88.00	\$114.00	—	—
2'-6" x 2'-0"	—	123.00	—	—
2'-6" x 2'-6"	—	126.00	—	—
3'-0" x 2'-0"	—	—	\$128.00	—
4'-0" x 2'-0"	—	—	—	\$151.00

SASH LAYOUT			
	Top Rail	Bottom Rail	Stiles
Cellar Sash	1 1/16"	1 1/16"	1 1/16"
Barn Sash	1 1/16"	1 1/16"	1 1/16"
Single Sash	2"	3 3/16"	2"

NOTES: Sash are treated with a preservative which acts as a moisture repellent and protects against decay.



Please read these requirements carefully for maximum service and satisfaction.

STORAGE AND HANDLING

1. Windows should always be stored in a clean, dry, well-ventilated building.
2. Do not store windows at the jobsite until concrete floors, foundations and plasterwalls are thoroughly dry.
3. Windows should not be exposed to excessive heat, dryness, or direct sunlight.

INSTALLATION (WINDOW UNIT)

1. Allow windows time to acclimate to a normal relative humidity for your area prior to installation.
2. Frame opening properly. **Plumb, Level and Square.**
3. Make sure opening is properly dimensioned. For masonry be sure to allow for caulking.
4. Close sash and secure lock (if applicable).
5. Center window in opening and make sure sill plate is level. Block sill from sill plate at side jamb area.
6. Shim at midpoint area between jamb and stud. Shim properly to avoid causing jambs to bow.
7. Check to make certain unit is plumb, level and square. Secure unit in wall by nailing through the exterior casing.
8. Insulate between jamb and rough opening on all sides with fiberglass insulation. **CAUTION:** Do not overpack insulation, which may cause jamb to bow. Avoid using expandable type foam insulation materials. This may also bow jambs causing difficult operation.

REMOVAL AND INSTALLATION (SASH AND BALANCES)

1. Allow sash time to acclimate to a normal relative humidity for your area prior to installation.
2. Carefully remove the side and head stops using a small prybar or stiff blade putty knife (in some instances, these stops may be held in place with screws). Do not discard, as you will make use of both the head and side stops again later.
3. Lift the bottom sash out of opening and detach sash cord, chain or other support method.
4. Remove the side and head parting beads. It may again be necessary to use a prybar. Retain the head parting bead, as it will be reused after the new sash are installed. Remove top sash by lifting out the opening and detaching the sash cord.
5. Remove the old sash pulleys and weights.
6. Insulate the window weight cavities.
7. Install new balances and sash according to instructions provided.
8. Test both sash to ensure proper operation. Reinstall the head parting bead and window stops.

FINISHING

1. Finish must be applied to the window immediately after installation, but not during or immediately after high moisture periods.
2. Surfaces must be clean and dry.
3. Sand interior of window with 180 grit sandpaper.
4. Thoroughly remove all dust with a tack cloth before applying finish.
5. **Painting:**

To finish the **Exterior** - use only a high quality paint, carefully following the manufacturer's instructions. **Do not use dark colored paint on surfaces receiving direct sunlight.** Only a high quality paint is acceptable as an exterior finish (stain is not acceptable as an exterior finish).

- Frame, casing and exterior face of sash is factory primed with acrylic latex primer.
- Paint all parts exposed to the elements with two additional coats of high quality exterior paint following manufacturer's instructions (including top and bottom of sash).
- All exterior finishes must have ultra-violet (UV) inhibitors in the finish.
- Apply top coats generously to bridge the gap between wood and glass. Lap paint onto glass $\frac{1}{16}$ " to protect against moisture penetration.
- Do not paint the window balance or weatherstripping.

To finish the **Interior** - use a high quality paint or stain (wood sash only), carefully following manufacturer's instructions.

- The interior will accept stain more uniformly if a "pre-stain", "sanding sealer" or "conditioner" is used prior to staining.
- Apply semi-transparent stain or a clear undercoat to the interior.
- Apply three coats of clear top coat, such as varnish or polyurethane.

When windows are replaced under warranty, BROSCO and manufacturer are not responsible for replacement or labor costs.

Manufacturer will not be responsible for windows that are not installed properly and/or finished properly.